

02/2023

# endrich NEWS

[www.endrich.com](http://www.endrich.com)

## LIEFERKETTENGESETZ: QUO VADIS?



Wolfgang Endrich

Das Lieferkettengesetz bedeutet, dass alle Importeure mit einer Personalstärke von 1.000 und mehr Mitarbeitern verpflichtet werden, sich mit ihren ausländischen Lieferanten, also z. B. in Vietnam, Kambodscha, Thailand, auseinanderzusetzen, um sicherzustellen, dass die Mitarbeiter unter menschenwürdigen Arbeitsbedingungen an sicheren Arbeitsstellen arbeiten und ein fairer Lohn ausbezahlt wird. Arbeitsschutzgesetze sind Mangelware!

Wenn man aber die Situation in Fernost besser kennt, weiß man, dass dies in vielen Fällen fast unmögliche Forderungen sind. Die Lieferanten fühlen sich in ihrer Freiheit bedrängt, zum Teil haben sie auch Untertierlieferanten, sodass es fast unmöglich ist, die gewünschten Informationen nach dem Gesetz zu erfüllen. Man findet es unangemessen, solche Firmendaten zu publizieren und Fremden Kontrollmöglichkeiten über die eigene Firma zu ermöglichen.

Wir wissen aber, dass es sehr oft Mängel bei der Einhaltung der Sicherheitsvorschriften gibt und teilweise auch chaotische Zustände in den Betrieben herrschen, ferner oft Hungerlöhne bezahlt werden. Natürlich sind dies für uns und unsere Maßstäbe völlig inakzeptable Bedingungen. Aber die dortigen Regierungen sehen dies wohl anders.

Vielleicht sollte man diese Situation aber einmal von der anderen Seite betrachten: Wir, das heißt die Verbraucher aus Deutschland, aber auch aus Europa oder den USA, wünschen niedrige Preise, z.B. in der Textil- und Elektronikindustrie. Deshalb fertigt Apple seine Mobiltelefone in Fernost oder kaufen wir Baumwolle aus Kasachstan und lassen sie dort bearbeiten und sogar konfektionieren. Das heißt, wir haben mit Absicht die Produktion aus Europa nach Fernost verlagert, wo es schön billig ist. Und diese Länder hängen am Tropf der Exporte und benötigen Exporterlöse.

Eigentlich hat sich seit der Kolonialzeit, wo England, Spanien und Portugal, die Länder in Südamerika und Indien ausgebeutet haben, nicht allzu viel geändert. Unser Wohlstand geht zu Lasten dieser Lieferländer.

Das nennt man nach meiner Meinung Ausbeutung. Unsere Argumentation ist dagegen ganz einfach: durch diese Industrieverlagerung nach Fernost geben wir den dort lebenden Menschen überhaupt eine Möglichkeit, einen Verdienst zu erwirtschaften und damit Hunger, Kindersterblichkeit, grenzenlose Arbeitslosigkeit und Hoffnungslosigkeit zu vermeiden. Aber die Frauenrechte bleiben trotzdem beschränkt.

Und wir treten als Gutmenschen auf und fordern, wie z.B. bei der Olympiade in Dohar mehr Rechte für die Frauen. Wollen wir die ganze Welt mit unserer Besserwisserei beglücken?

*Lesen Sie weiter auf Seite 2*

# endrich

Fortsetzung von Seite 1

## LIEFERKETTENGESETZ: QUO VADIS?



Denn Asien tickt anders! Andere Religionen, uralte Riten und Sitten bestimmen immer noch das dortige Leben, und das sollten wir verstehen lernen und respektieren.

Die alten Lehrer der Volkswirtschaftslehre wie Keynes und andere hatten zwar recht mit dem „Wandel durch Handel“. Aber Krisen, wie Corona und Krieg, wurden nicht einbezogen. Dazu kam das Erliegen von Luft- und Seeverkehr. Viele Container mit Weihnachtsprodukten lagern noch heute in den chinesischen Häfen. Und jetzt spüren wir unsere totale Abhängigkeit von Fernost-Lieferungen, wie z.B. Arzneimitteln, Rohstoffen und anderen.

„Geiz ist halt nicht geil!“ Politik und Wirtschaft sind endlich aufgewacht. Die „Zeitenwende“ hat vieles geändert.

Und das Lieferkettengesetz? Die EU sollte es besser wieder zurückziehen! Keiner wird dieses Gesetz vermissen. Und die Weltwirtschaft macht es auch nicht besser.

Eines sollte uns klar werden: von unserem bisher gelebten Wohlstand werden wir Abstriche machen müssen, denn die Konsequenzen aus der bisherigen Politik werden jetzt schmerzhaft deutlich.

Wolfgang Endrich

# NEWS

## PLATINUM-CHIP-TEMPERATURE SENSORS

according to DIN EN 60751

Platinum-chip temperature sensors belong to the category of thin-film technology temperature sensors

During the manufacturing of these temperature sensors, a thin layer of platinum is deposited on a substrate of ultrapure aluminum oxide ceramic and structured in a meander-style pattern.

The temperature sensors are based on a temperature-dependent resistance, the curve and admissible tolerance of which are defined in the international standard IEC 60751:2008. The thin film technology used enables the production of particularly small and robust design types. The favorable, linear characteristic curve, the wide temperature measuring range, and high measuring accuracy, together with outstanding long-term stability, make these standardized temperature sensors the ideal choice.

The sensors are delivered in belt packaging in standard rolls. The temperature sensor is available as a wrap-around contact (type PCS) or with one-sided contact (type PCF (flip chip)) for "face-down installation". The flip chip types (see Fig. Type PCF...B) can be provided with a complete solderable nickel/gold metal layer on the rear/underside. This enables direct thermal contact with another body via a solder connection.

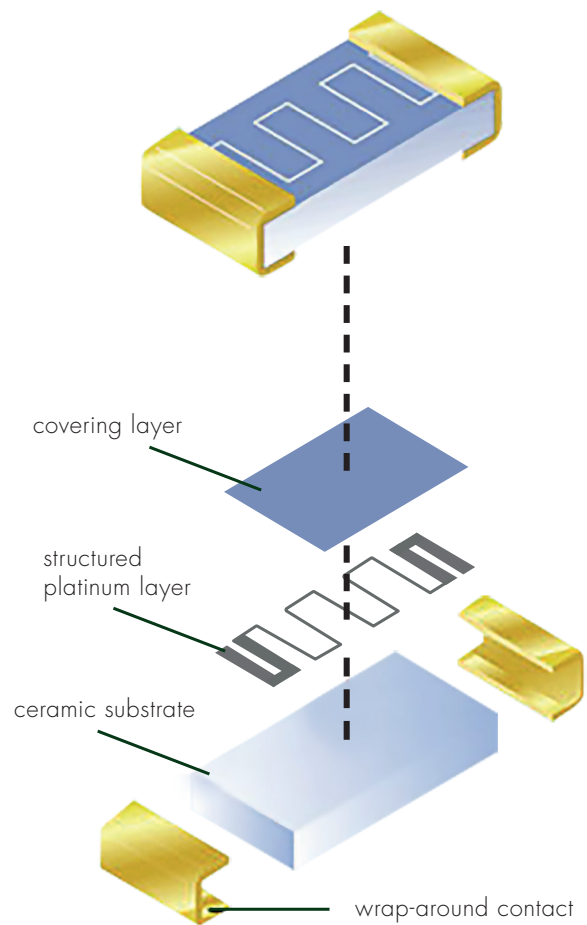

### APPLICATIONS

- E-mobility
- Sensor solutions
- Temperature probes
- PCBs

### FEATURES

- For temperatures from  $-50$  to  $+150$  °C ( $-70$  to  $+250$  °C)
- In accordance with DIN EN 60751, nominal values Pt100, Pt500 and Pt1000
- Tolerance classes F0.1, F0.15, F0.3 (standard) and F0.6
- SMD design type 1206 (3216M) and 0805 (2012M)
- Gold-plated nickel solder contact
- Solderability according to IEC / DIN EN 60068-2-58
- Belt packaging according to DIN IEC 60286-3
- High load capacity

## DEVELOPMENT OF “UPWARD-LIGHTING MULTICOLOR LEDs”

Small, high brightness LED packages that have an improved color mixing property

Enabling the use of a wide variety of expressions related to products

Citizen Electronics Co., Ltd (Head Office: Fujiyoshida City, Yamanashi Prefecture.President: Sekiguchi Kanetaka) has developed upward-lighting multicolor LEDs in the “CL-V501 Series,” that have realized a better color mixing property as well as being small and high in brightness. Shipment of samples is expected to start from October 2021, and shipment of mass production is expected to start from January 2022.

### Upward-lighting multicolor LED

Product name: CL-V501 Series

Type: Upward

Size: W 1.6 mm x L 1.4 mm x H 0.55 mm

Applications: Illumination and indicators for game devices, keyboards for personal computers, home appliances, hobby goods, displays, ambient lighting for automobiles, colored lighting

Date of sale: Shipment of samples is expected to start from October 2021, and shipment of mass production from January 2022.

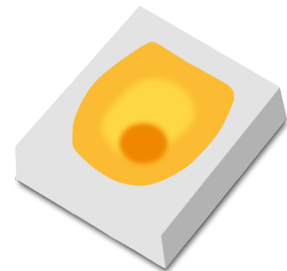

### Background for development

Multicolor LEDs have three dies of RGB (Red, Green, and Blue), which are light's primary colors, in one package. That is why they can generate various colors including white by mixing the colors and are used for illumination or as indicators in many kinds of devices such as digital devices. In recent years, applications for illumination in game devices, keyboards for personal computers and amusement devices have been expanding. The number of devices that contain a lens and light guide to create a complicated lighting expression has increased. With this background, smaller, high brightness LEDs are required, and good color mixing properties when more than two dies are lighted simultaneously, is an important factor so as





not to damage the design and functionality of the device. Through our unique packaging technology based on high-density packaging, we have realized a high color mixing property which conventional packages were unable to achieve. Downsizing and high brightness is also achieved enabling customers to use a wide variety of expressions they require.

# NEWS

## Main characteristics –

### Natural white color realized by high color mixing property

White color generated by lighting RGB dies in conventional multicolor LEDs had poor color mixing property, and it was difficult to use as white color. Thus, in some cases, RGBW LED was used, in which white (W) LED is added to RGB. This solution makes the LED package larger and circuit design of the device complicated and was expensive. However, by developing the composition of raw materials and adopting a new manufacturing method, we have succeeded in controlling directivity in the device itself. The natural white color is realized with this high color mixing property. As the light source does not generate color breakup, design is improved as well to meet various applications. Even in cases where a lens and light guide plate are used, it is easier for customers to create designs because the light source itself has color mixing.

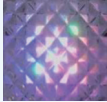
NEW PRODUCT (CL-V501)	CONVENTIONAL PRODUCT (CL-341)
	
Image of color mixing	
	
Real picture taken through a lens	
<p>No color breakup is generated when RGB dies are lighted simultaneously. Natural white color can be emitted.</p>	<p>Color breakup is generated when RGB dies are lighted simultaneously. Color mixing property is too low to use as white color.</p>

### Both high-brightness and small size are realized, and luminous efficacy per unit area is doubled

We have further developed our high-density packaging technology to achieve a small package with good color mixing properties. Compared with our conventional product, area of the product is reduced by 30%, and luminous area is reduced by 50%. This downsizing contributes to space-saving of the mounting area of the device, and the doubling in luminous efficacy per unit area can reduce energy consumption.

#### 1 New product CL-V501

W 1.6 mm x L 1.4 mm = Mounting area is 2.24 mm<sup>2</sup>  
(Luminous area is 1.34 mm<sup>2</sup>)

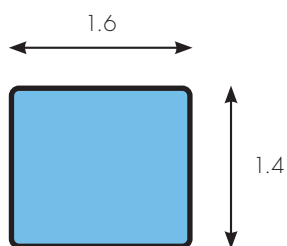

1 New product (CL-V501)

#### 2 Conventional model CL-341

W 2.0 mm x L 1.6 mm Mounting = area 3.20 mm<sup>2</sup>  
(Luminous area is 2.62 mm<sup>2</sup>)

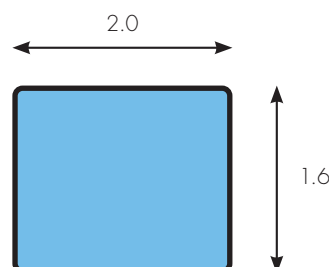

2 Conventional model (CL-341)

## SINGLE-CELL NVDC BATTERY CHARGER FAMILY INTRODUCTION

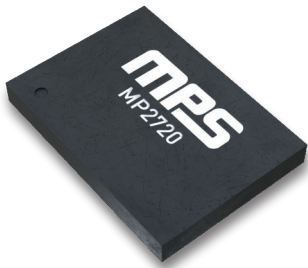

MP2720: 2.5A, Single-Cell NVDC Buck Charger

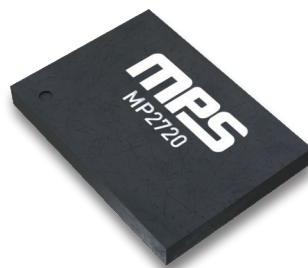

MP2720A: 2.2A, Single-Cell Buck Charger with 15 mA Termination Current

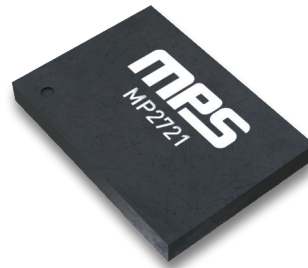

MP2721: 5A, Single-Cell NVDC Buck Charger



MP2722: 5A, Single-Cell NVDC Buck Charger with Integrated USB Type-C DRP Detection

The new MP272xx Battery Charging Family is a switch-mode battery management device for single-cell Li-ion or Li-polymer batteries. The narrow-voltage DC (NVDC) power management structure provides a low impedance power path, that optimizes charging efficiency, reduces battery charging time, and extends battery life during discharging. The device's input source type identification algorithm supports USB battery charging specification 1.2 (BC1.2) and non-standard adapter detection. The I2C interface offers complete operating control, including charging parameter configurations and status/interrupt monitoring. The MP2720 supports a fully customizable JEITA profile with configurable temperature windows and actions.

### Typical application

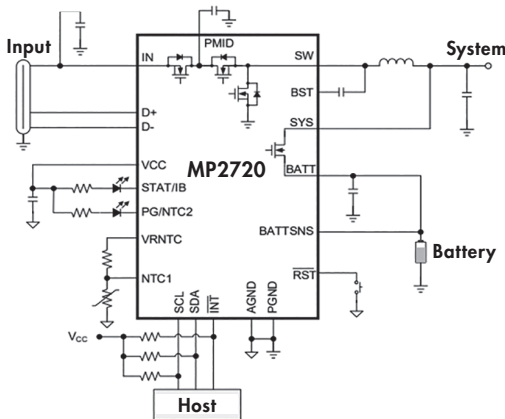

### Package reference

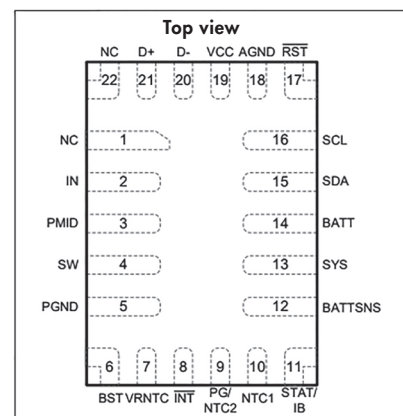

QFN-22  
(2.5 mm x 3.5 mm)

### APPLICATIONS

- General  $\leq 15W$  USB Applications
- Bluetooth headphones
- Bluetooth speakers
- Point-of-Sale (POS) terminals
- Portable cameras
- EVKT-MP2720 are available

### FEATURES

- **MP2720xx 2.5A**, Single-cell NVDC buck charger
- **MP2720Axx 2.2A**, Single-cell buck charger with 15 mA termination current
- **MP2721xx 5A**, Single-cell NVDC buck charger
- **MP2722xx 5A**, Single-cell NVDC buck charger with integrated USB type-C DRP detection



# NEWS

## NEW RADAR SENSOR FROM RFbeam

As a logical extension of its 24GHz and 61GHz radar sensor portfolio, RFbeam unveiled its latest development at Electronica 2022 in Munich

K-MD7 24GHz digital  
2D radar transceiver

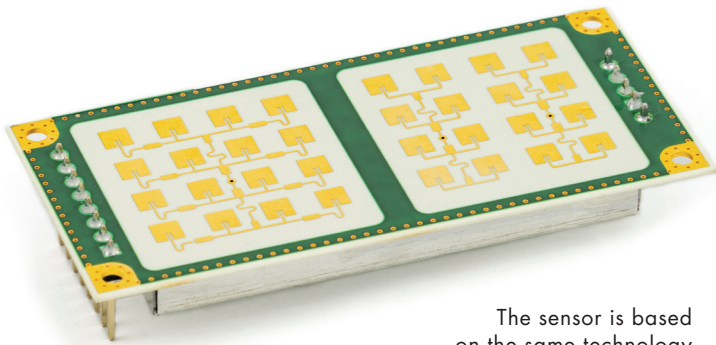

The sensor is based on the same technology as the already known K-LD7 sensor.

A wide range of filter functions and parameters help optimize sensor functionality for different application requirements.

No special knowledge of analog or digital signal processing is required, which speeds up the time-to-market for new developments.

In addition to the sensor, an evaluation kit is also presented, which enables convenient parameterization and evaluation of the sensor in the usual RFbeam manner.

### FEATURES

- Speed, distance, and angle measurement
- Detects moving objects up to 200 km/h
- FSK signal processing with tracking included
- Multi-target tracking for up to 8 moving objects
- Target list output over serial UART interface
- Wide operating voltage range of 3.2 to 5.5 V
- 34 x 34-degree beam pattern
- Detection distance: 50 m (persons) / 150 m (cars)

The K-MD7 is an evolution of the successful K-LD7 with a narrower antenna and more processing power. This allows higher detection distances and tracking of multiple objects up to 200 m.

K-MD7 evaluation kit

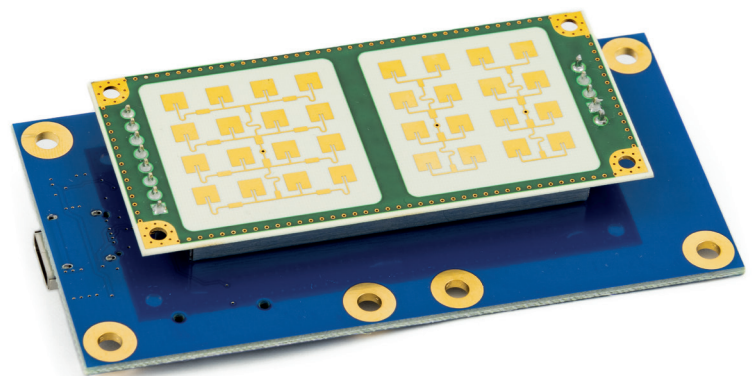

First evaluation kits will be available from Q2 / 2023

## NEW RADAR SENSOR FROM RFbeam

V-LD1 61 GHz FMCW radar distance sensor

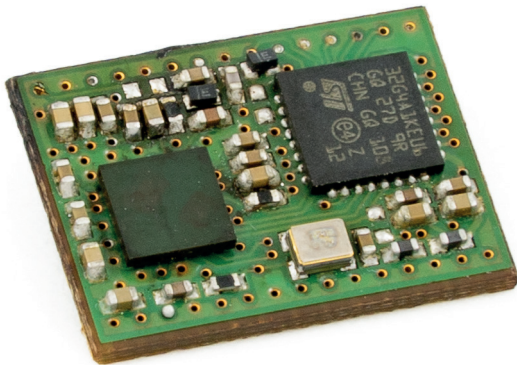

RFbeam unveiled its latest development at Electronica 2022 in Munich, Germany. A small and low cost 61 GHz FMCW distance measurement sensor.

### FEATURES

- Precise distance measurement with mm accuracy
- Fully digital with distance output over serial interface
- Ultra Small SMD form factor (12 mm x 16 mm)
- Single 1.8 V power supply for simple integration
- Low power mode with lower duty cycles
- Usable as robust touchless switch
- Perfect for simple tank leveling applications

No special knowledge in analog or digital signal processing is needed to adapt the module to different applications resulting in a fast time to market. Transmit frequency and sweep bandwidth are controlled internally and a selection of settings is available to adapt to your application requirements.

The beam width of the module itself is 80 x 80 degrees. However, RFbeam also offers an evaluation kit in combination with a plastic lens that focuses the beam to 6 x 6 degrees, which is perfect for tank leveling applications.

V-LD1 evaluation kit

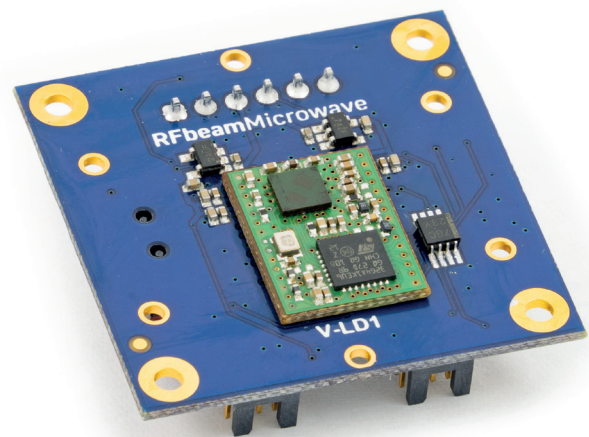

First evaluation kits will be available from Q2 / 2023



Contact for information: Mr. Deuschle · phone: +49 7452 6007-929 · e-mail: w.deuschle@endrich.com

**RFbeam**

### HEADQUARTERS

endrich Bauelemente Vertriebs GmbH  
P.O.Box 1251 · 72192 Nagold,  
Germany  
T +49 7452 6007-0  
E [endrichnews@endrich.com](mailto:endrichnews@endrich.com)  
[www.endrich.com](http://www.endrich.com)

### SALES OFFICES IN EUROPE

**France**  
Paris:  
T +33 1 86653215  
[france@endrich.com](mailto:france@endrich.com)

**Lyon:**  
T +33 1 86653215  
[france2@endrich.com](mailto:france2@endrich.com)

**Spain**  
Barcelona:  
+34 93 2173144  
[spain@endrich.com](mailto:spain@endrich.com)

**Bulgaria**  
Sofia:  
[bulgaria@endrich.com](mailto:bulgaria@endrich.com)

**Austria & Slovenia**  
Gmunden:  
+43 1 6652525  
[austria@endrich.com](mailto:austria@endrich.com)

**Romania**  
Timisoara:  
[romania@endrich.com](mailto:romania@endrich.com)

**Hungary**  
Budapest:  
T +36 1 2974191  
[hungary@endrich.com](mailto:hungary@endrich.com)

**Switzerland – Novitronic**  
Zurich:  
T +41 44 30691-91  
[info@novitronic.ch](mailto:info@novitronic.ch)

If you no longer wish the endrich news by mail, please write an e-mail to [newsletter@endrich.com](mailto:newsletter@endrich.com)

Certified acc. to ISO 9001:2015 / 14001:2015