

CIRCUIT PROTECTION SHORTFORM CATALOG

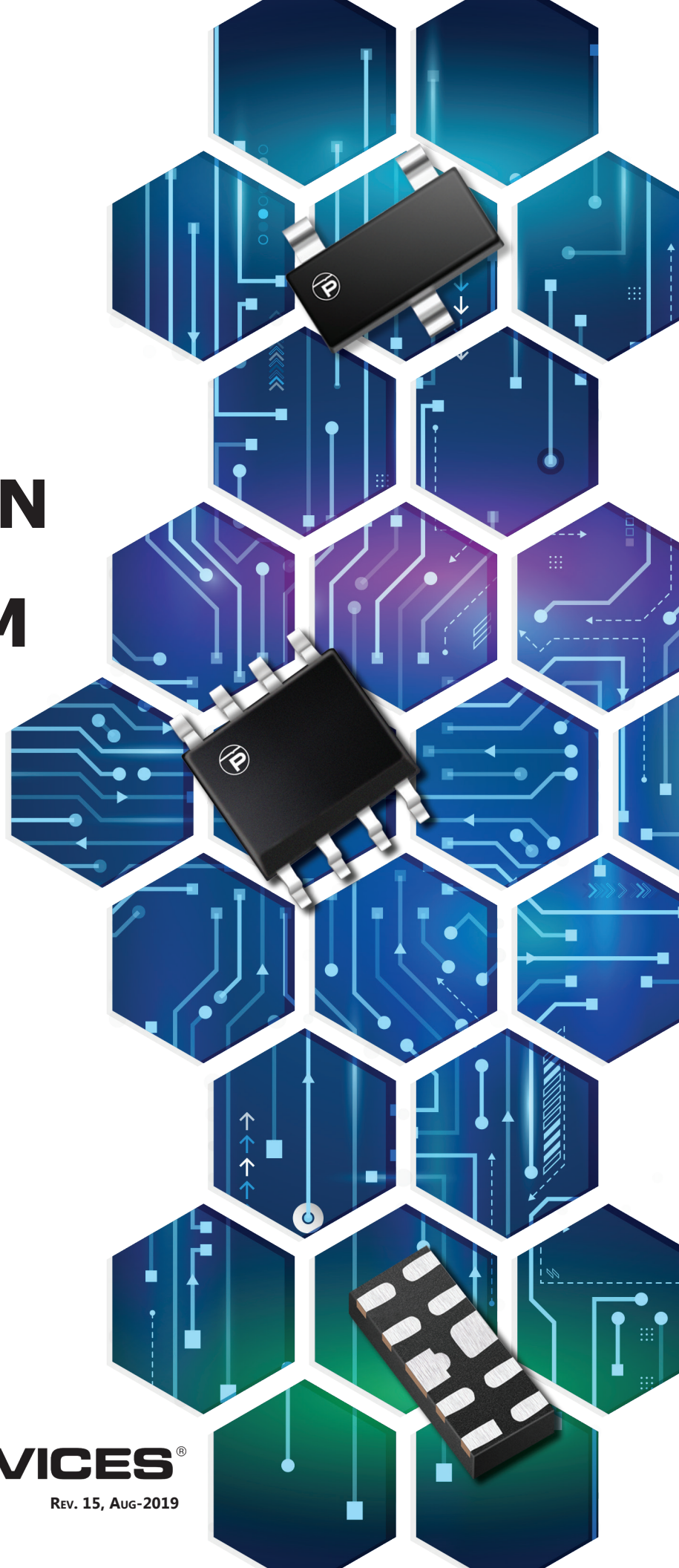

PROTEK DEVICES®

REV. 15, AUG-2019

TABLE OF CONTENTS

Product Index – Alphanumeric	2
Unidirectional TVS Device Selection Process.....	5
Bidirectional TVS Device Selection Process	6
Solutions by Application.....	7
TVS Diode Arrays.....	11
Steering Diode/TVS Combo	37
Flip Chip Arrays	43
TVS Diode/Thyristor	43
Steering Diodes.....	44
EMI Filter/TVS Diode Arrays	48
Thyristors.....	49
Module – Components	50
Module – Surgebusters™	54
Overcurrent Protection - Fuses	56
Overcurrent Protection – Polymer PTC Devices.....	58
Standards and Waveforms	59
DO-160G Waveforms	61
Product Packaging	63

ATTENTION

- Not all voltages, configurations or packages are shown. Please contact customer service for more information.
- ProTek offers protection devices for Automotive applications. The part numbers begin with the prefix 'PAM'.
- ProTek offers protection devices for LED applications. The part numbers begin with the prefix 'PLED'.
- All devices, with the exception of those contained within the Modules-Components and Modules-SurgeBuster sections are Lead-Free, ROHS compliant. These products are designated as "lead free" and meet the requirements of the European Union's restriction on the use of hazardous substances in electrical equipment as stated in (RoHS) direction, 2002/95/EC. ProTek Devices defines "lead free" as products that are compatible with current RoHS requirements for the 6 "banned" substances: Lead (Pb, <1000ppm), Cadmium (Cd, <100ppm), Mercury (Hg, <1000ppm), Hexavalent Chromium (Cr6+, <1000ppm), Poly Brominated Biphenyls (PPB, <1000ppm), Poly Brominated Diphenyl Ethers (PBDE, <1000ppm). This includes the requirements that lead not exceed 0.1% by weight in homogeneous materials.
- The following packages are REACH Compliant: Axial Leads, DFNs, DIPs, Flip Chips, MSOPs, QFNs, SCs, SODs, SOICs, SOTs and VSIPs
- Standard Tape & Reel Nomenclature
 - -T7 for 7" Reels, i.e., PSOT05-T7
 - -T71 for 7" Reels 1,000 pieces per reel, i.e., ESD4-LFC-T71
 - -T73 for 7" Reels 3,000 pieces per reel, i.e., ESD4-LFC-T73
 - -T13 for 13" Reels, i.e., SM8LC05-T13
 - -TS for sample size Reels, i.e., SM16LC05C-TS

Not all products are available in 7" or 13" reels. Quantities per reel vary depending upon package size. Please consult the product datasheet or customer service for ordering information regarding a specific part series. All datasheets can be found on ProTek Devices website: www.protekdevices.com

Do not put products into life support systems without written consent from ProTek Devices.

ALPHANUMERIC - INDEX

1.0SMBJxxA/CA Series	11	P0402VP24	16
1.5KExxA/CA Series	50	P0404FCxxC Series	43
1.5SMCxxA/CA Series	11	P0603V24	16
15KP Series	50	P15KP & P30KP Series	51
15KPA Series	50	P5V0S1UL	16
232B & E	54	P5V0S1ULC	16
2700SM78CAN	50	P45MAxxA/CA Series	17
30KPA Series	50	P6KExxA/CA Series	51
420E Series	54	P6SMBxxA/CA Series	17
420LB & LE Series	54	PAM01SC7905C	17
422B & E	54	PAM02SD23xx/C Series	17
422ELC	54	PAM03SD23xxCI Series	17
485ELC	54	PAM04DF100524	37
5.0SMDJ Series	11	PAM04ST430502	37
587B Series	54	PAM05SC700504F	37
587BLP Series	54	PAM06SC7905S	17
587BLPE Series	54	PAM07DF23K24	51
5KPxxA/CA Series	50	PAM08SD23xx/C Series	17
60 & 90KS200C	50	PAM09SD2305HP	17
704 Series	50	PAM1CAN	18
CPxx/C Series	11	PAM1FLEX	18
DA8 Series & DA16 Series	11	PAM1IVN27	18
DALC112S1	44	PAM1LIN	18
DD3K Series	50	PAM2CAN	18
DFN6-36	12	PAM2IVN24	18
DFN8-36	12	PAM2LIN	18
DL0521P	12	PAM3CAN	18
DLZ Series	12	PAM5SxxA Series	18
DSL03-24	37	PAM6SxxA Series	19
DSL03-24T	43	PAM8SxxA Series	19
DSL70	44	PAM10ST23xxC Series	19
DSOT0502	13	PAM11SO803	19
EBLCxxC Series	13	PAM12SO824	19
EM02-100	48	PAM13ST2305	37
EM1631-08DPLP	48	PAM14ST6305LCC	19
EM4D/LP-100L	48	PAM15ST4305	37
EM8D/LP/SLP-100L	48	PAM16AL30A	51
EM8Q-100	48	PAM17DF2LC05C	19
ESD4-DFN	13	PAM18DF2L0521	19
ESDA05C-5	13	PAM19DF2L0521P	20
ESOT12LCC-1	13	PAM20ST6305	20
ESOT24LCC-2	13	PAM21SC790501H	20
ESOT3.3LC-2	13	PAM24DF1605	48
ESOT3.3LCC	13	PAM25DF25K Series	51
ET108	44	PAM27ST2324LC	20
ET720	44	PAM28DOACxxA/CA Series	20
ET721	44	PAM29DOAxxA/CA Series	20
ET723	44	PAM30DOABxxA/CA Series	20
ET724	44	PAM31DOABxxA/CA Series	20
GBLCxx/C Series	14	PAM32DOABxxA/CA Series	21
GBLCxxCDN Series	14	PAM33DOABxxA/CA Series	21
GBLCxxCDSL Series	14	PAM34ST2305	21
GBLCxxCIDFN Series	14	PAM35DOABxxA/CA Series	21
GBLC03CIDNHP	14	PAM36DOAxxA/CA Series	21
GBLC03CIHP	14	PAM37SDxxAL/CAL Series	21
GBLCxx/CI Series	14	PAZC099	37
GBLCxxLC/CLC Series	14	PBSP-10K Series	54
GBLCSCxx/C Series	15	PBSP-20K Series	54
GBLCSC08CLC	15	PDFN2-32	21
GBLLC03/C Series	15	PDFN3-32	21
GPZ Series	51	PDLC05	22
GPZ1275B60K	51	PDTV5xxCA Series	51
IO6LC	44	PESD1CAN	22
K Series	51	PESD1FLEX	22
LCA & LCD Series	15	PESD1LIN	22
MAD Series & MAD1108	45	PESD2CAN	22
MMAD Series & MMAD1108	45	PESD05B	22
MSMFxx/C Series	15	PESD05BLC	22
MSMF05LC & MSMF05LCC	15	PESD12LCB	22
P0201D05C	16	PESD12ULC	22
P0201V05	16	PESD24V	22
P0402FCxxC Series	43	PESD2402	23
P0402V Series	16	PESD27V	23

PRODUCT INDEX - ALPHANUMERIC

PESD3V3	23	PSDxx/C Series	26
PF0402F Series.....	56	PSDxx61 Series	27
PF0603F Series.....	56	PSDxxHP Series.....	27
PF0603H Series	56	PSLCxx/C Series	27
PF0603S Series	57	PSM712	27
PF1206F Series.....	57	PSMDA05-6	27
PF1206H Series	57	PSMDAxxC-4 Series	27
PF1206S Series	58	PSMDAxxC-8 Series	27
PHP & PIP Series.....	52	PSMF05	28
PLC01-6	23	PSMFxxAL/CAL Series.....	28
PLC03-3.3.....	23	PSMP30-240	43
PLR03-.3.H	23	PSMSxx/C Series	28
PLC03-3.3-DFN	23	PSOTxx/C Series	28
PLC03-xxLC Series.....	23	PSOTxx3/C3 Series	28
PLC03-6	37	PSOT05CLP	28
PLC496	24	PSOTxxKCA Series	28
PLC497	37	PSOTxxLC Series	29
PLCDA Series	24	PSOT05LCC.....	29
PLCDAxxC-6 Series	24	PSOT05ULC	29
PLED05F189	24	PSR05	40
PLED0811PU	24	PSR05LC	40
PLED3631X23NB	24	PSR3.3	40
PLED508.....	24	PSRDA70-4	47
PLED508U.....	24	PSRDAxx-4 Series.....	40
PLED511.....	24	PSRDAxx-4A Series.....	40
PLED511U.....	24	PSRDAxx-6 Series.....	40
PLR0502.....	38	PSRDAxx-6A Series.....	40
PLR0502-6.....	38	PSRVxx-2LC Series	40
PLR0503.....	25	PSSB05P	29
PLR0504F	38	PTB05-8ULC.....	29
PLR0504PLCN.....	38	PTVSxxA Series	29
PLR0506.....	38	PUSB05UBK	41
PLR0506LP.....	38	PUSB403	41
PLR0508.....	38	PUSB6B	41
PLR0514LC	38	RSB6.8B	29
PLR05214LC.....	38	RSB6.8G.....	29
PLR0521.....	25	RSB6.8S.....	30
PLR0521E	25	SLVDA2.8LC.....	30
PLR0521U.....	25	SLVU2.8	30
PLR0522.....	39	SLVU2.8-4	30
PLR0524.....	39	SLVU2.8-4G	30
PLR0524P	39	SLVU2.8-8	30
PLR2210.....	39	SLVU2.8-8G	30
PLR2504.....	39	SM10KWxxA & SM10KWExxA Series	52
PLRxx12 Series	25	SM14MxxC Series	30
PLR2512H.....	25	SM16xx/C Series	30
PLR3304.....	39	SM16LCxx/C Series.....	30
PLR3304PLCN.....	39	SM15KPxxAN/CAN Series.....	52
PLR3343.....	39	SM15KWExxA/CA Series	52
PLR3311.....	25	SM30KPxxAN/CAN Series.....	52
PLR4045.....	39	SM45KPxxAN/CAN Series.....	53
PLRO1206 Series	59	SM3KW Series.....	53
PLRO1210 Series	60	SM5KW Series.....	53
PLW0501D.....	25	SM5SxxA Series	31
PLW0501H.....	26	SM6SxxA Series	31
PLW0501P	26	SM8SxxA Series	31
PLW1201H	26	SM8LC Series	31
PLW2.8	26	SMAJxxA/CA Series.....	32
PMAD Series & PMAD1108	46	SMBJxxA/CA Series.....	32
PMMAD Series & PMMAD1108.....	46	SMCJxxA/CA Series.....	32
PMPS-E-1206	58	SMDAxx/C Series.....	32
PMPS020-FH-1206.....	58	SMDAxx-6 Series	32
PMPS075-1812	58	SMDAxxCM Series.....	32
PMPS150-1812	58	SMDAxxCN-5 Series.....	32
PMPS150E-1206	58	SMDAxxLC/C Series	33
PMPS200-1812	58	SMDBxx/C Series.....	33
PMPS200D-1210.....	58	SMDB712C	33
PMPS260C-1812	58	SMDD3KxxA Series	53
PMPS380E-1206	58	SMDJxxA/CA Series	33
PP-SM Series.....	49	SMFxxC Series	33
PRSB6.8C	26	SMLCxxC-2 Series	33
PRSB6.8CT	26	SMP6LCxx-2P Series	34
PRSB6.8D.....	26	SMP6LLCxx-2P Series.....	34

PRODUCT INDEX - ALPHANUMERIC

SMSxx/C Series.....	34
SR12	41
SR Series.....	41
SR70	47
SRV05-4.....	41
SRV05-4-A.....	41
SRV05-4LC	41
SRV05-4M/T	41
SRV2.8-4.....	42
SRV25-4.....	42
SRV25-4LC	42
SRV3.3-4.....	42
STF701	48
TEL50B & E.....	55
TEL185B & E	55
U0402FCxxC Series.....	43
USB002	47
USB004	47
USB04xx/C Series.....	34
USB508xx/C Series	34
USB208	47
VSIP Series.....	34
VSB06P05LCI	35
VSMF05LC & VSMF05LCC.....	36

UNIDIRECTIONAL TVS DEVICE SELECTION PROCESS

TVS Clamping Characteristics

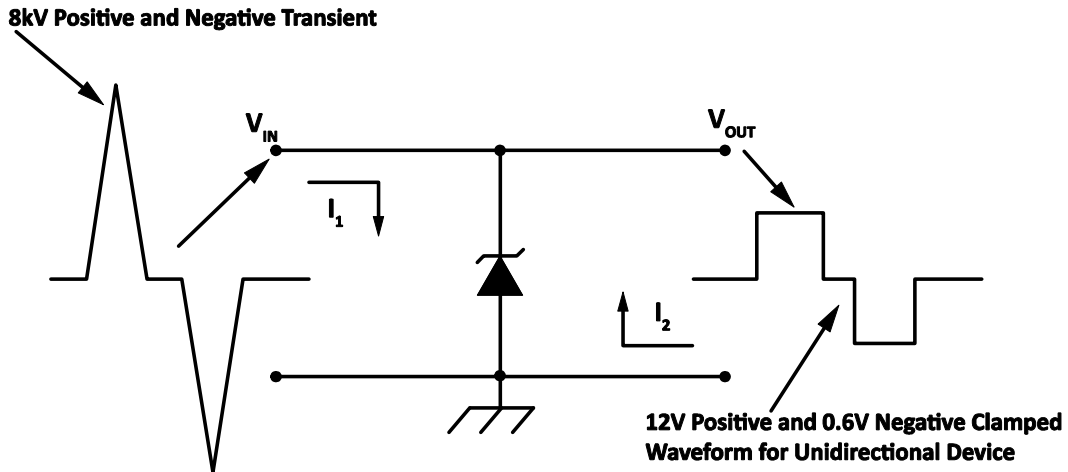

Unidirectional TVS



Avalanche Junction TVS VI Characteristics

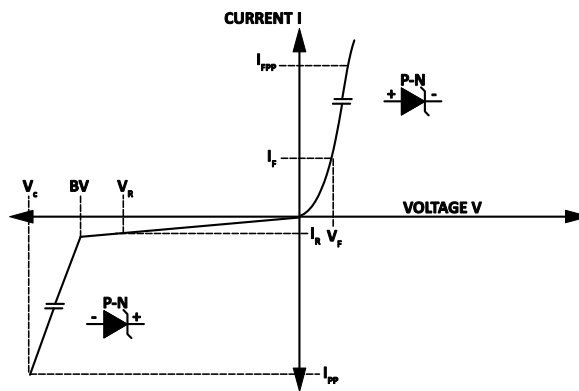

Symbol

B_V
 I_R
 V_R
 V_C
 I_{PP}

Parameter

Breakdown Voltage
 Leakage Current
 Reverse Stand-Off Voltage
 Clamping Voltage
 Peak Pulse Current

SELECTION PROCESS

TVS Parameters

Stand-Off Voltage (V_R) \geq
 Peak Pulse Current (I_P) \geq
 Clamping Voltage (V_C) \leq
 Input Capacitance of the Device \leq

Application Parameters

Operating Voltage (V_{OP})
 Transient Current (I_T)
 Voltage Withstand Level (V_{WS})
 Acceptable Line Loading for Functional Pass

BIDIRECTIONAL TVS DEVICE SELECTION PROCESS

TVS Clamping Characteristics

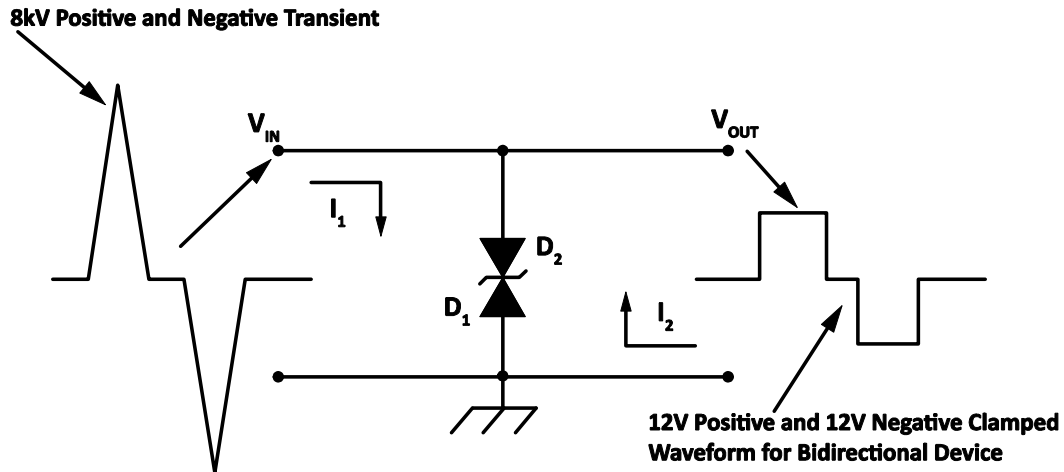

Bidirectional TVS



Avalanche Junction TVS VI Characteristics

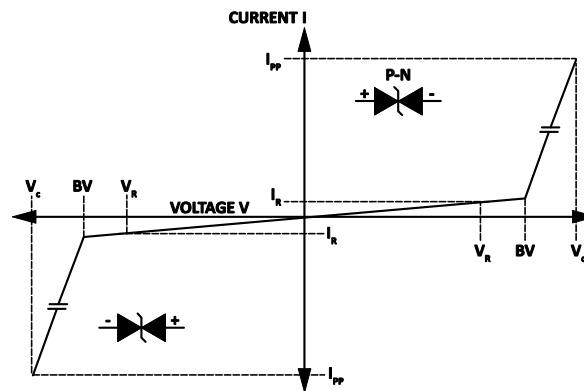

Symbol

B_V
 I_R
 V_R
 V_C
 I_{PP}

Parameter

Breakdown Voltage
 Leakage Current
 Reverse Stand-Off Voltage
 Clamping Voltage
 Peak Pulse Current

SELECTION PROCESS

TVS Parameters

Stand-Off Voltage (V_R) \geq
 Peak Pulse Current (I_P) \geq
 Clamping Voltage (V_C) \leq
 Input Capacitance of the Device \leq

Application Parameters

Operating Voltage (V_{OP})
 Transient Current (I_T)
 Voltage Withstand Level (V_{WS})
 Acceptable Line Loading for Functional Pass

COMMUNICATION APPLICATIONS

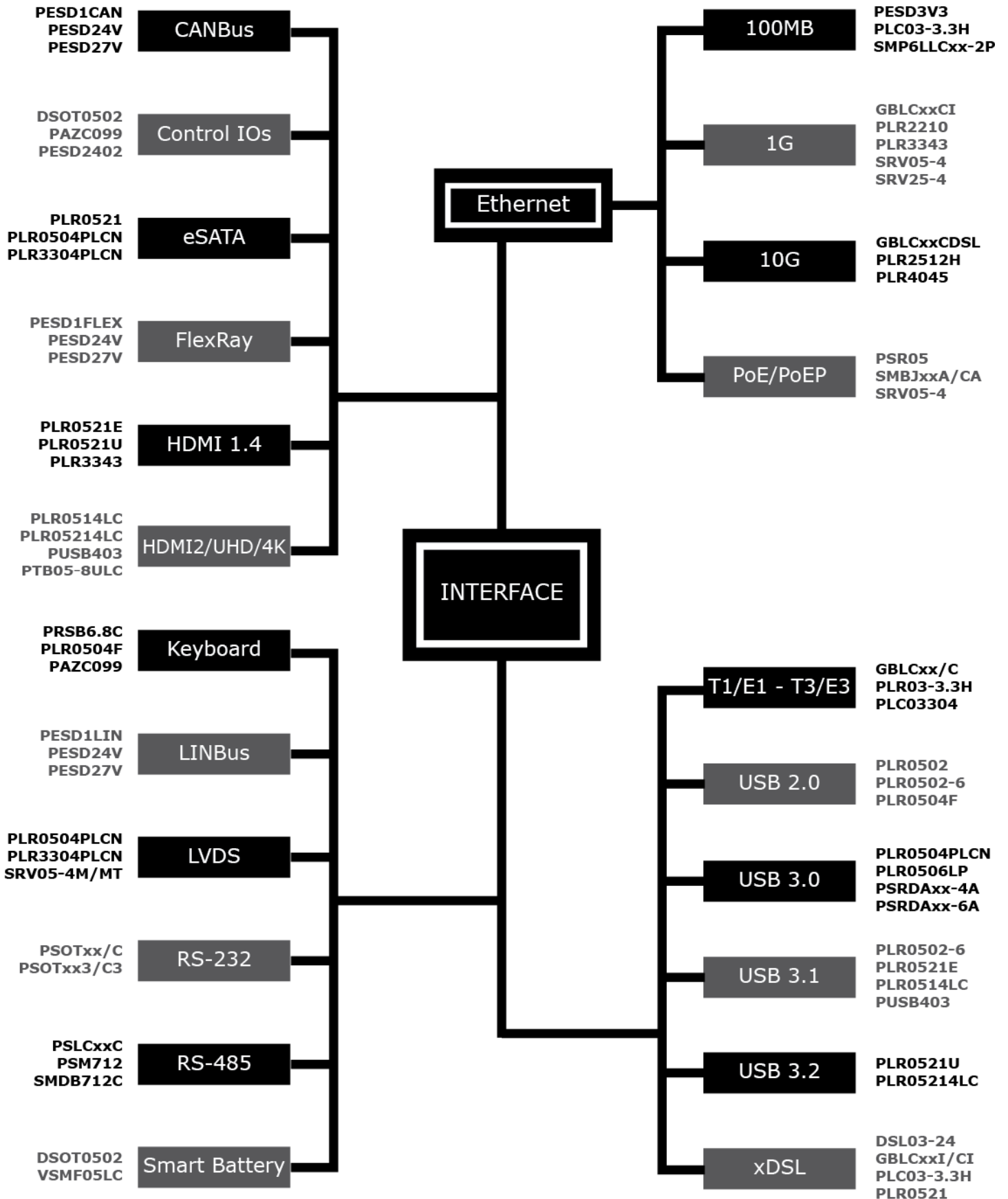

AUTOMOTIVE APPLICATIONS

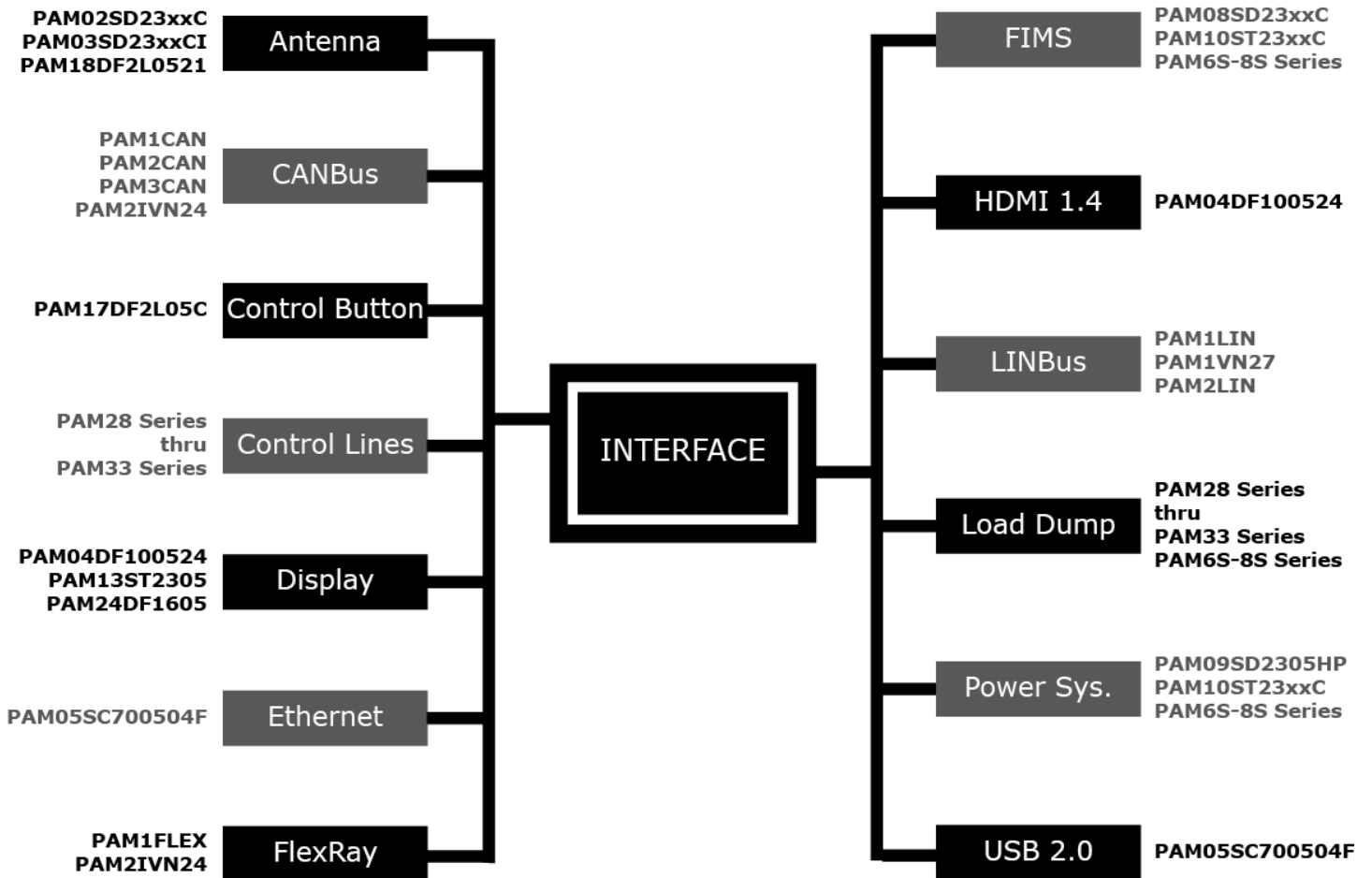

INDUSTRIAL APPLICATIONS

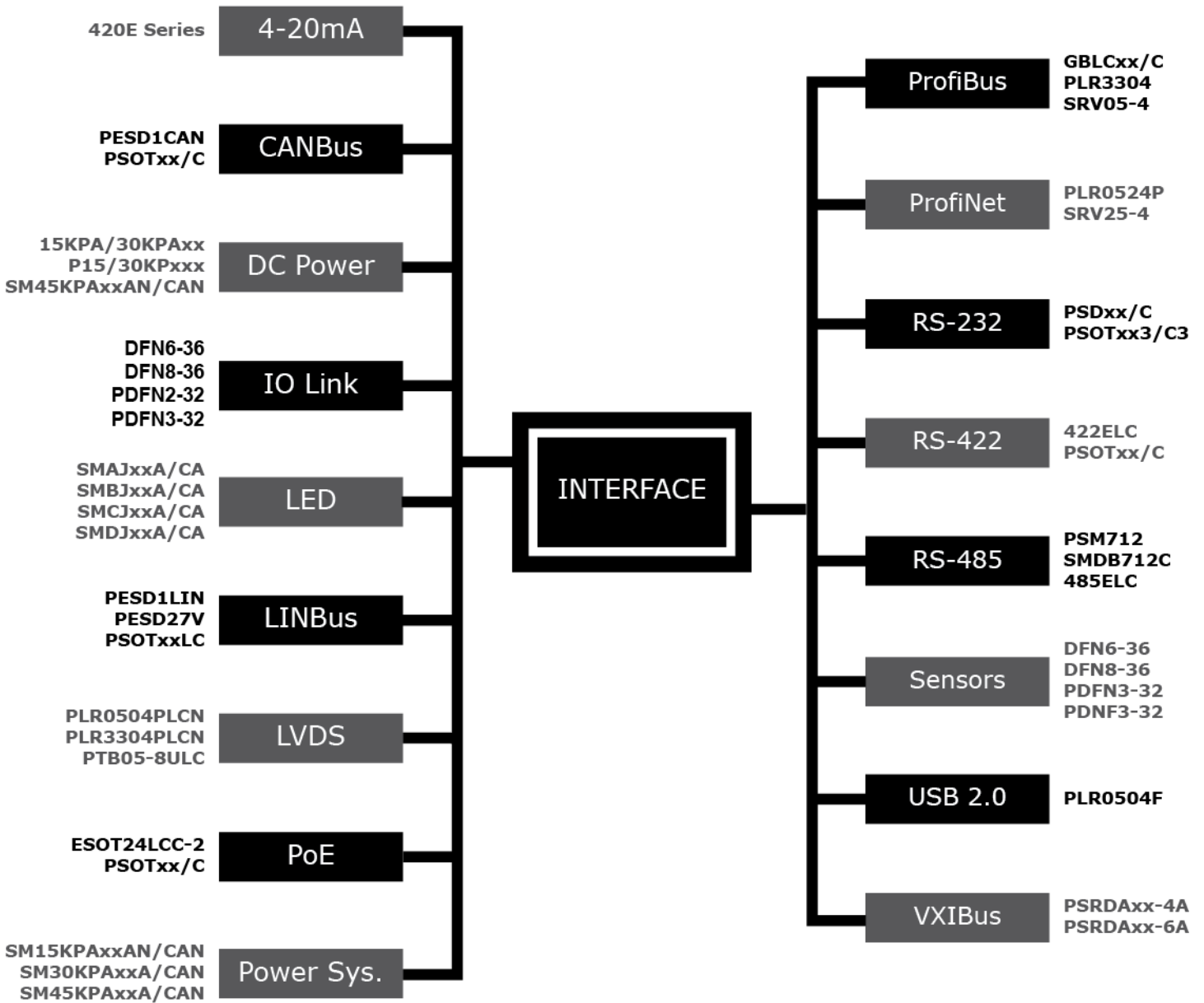

MILITARY/AEROSPACE APPLICATIONS

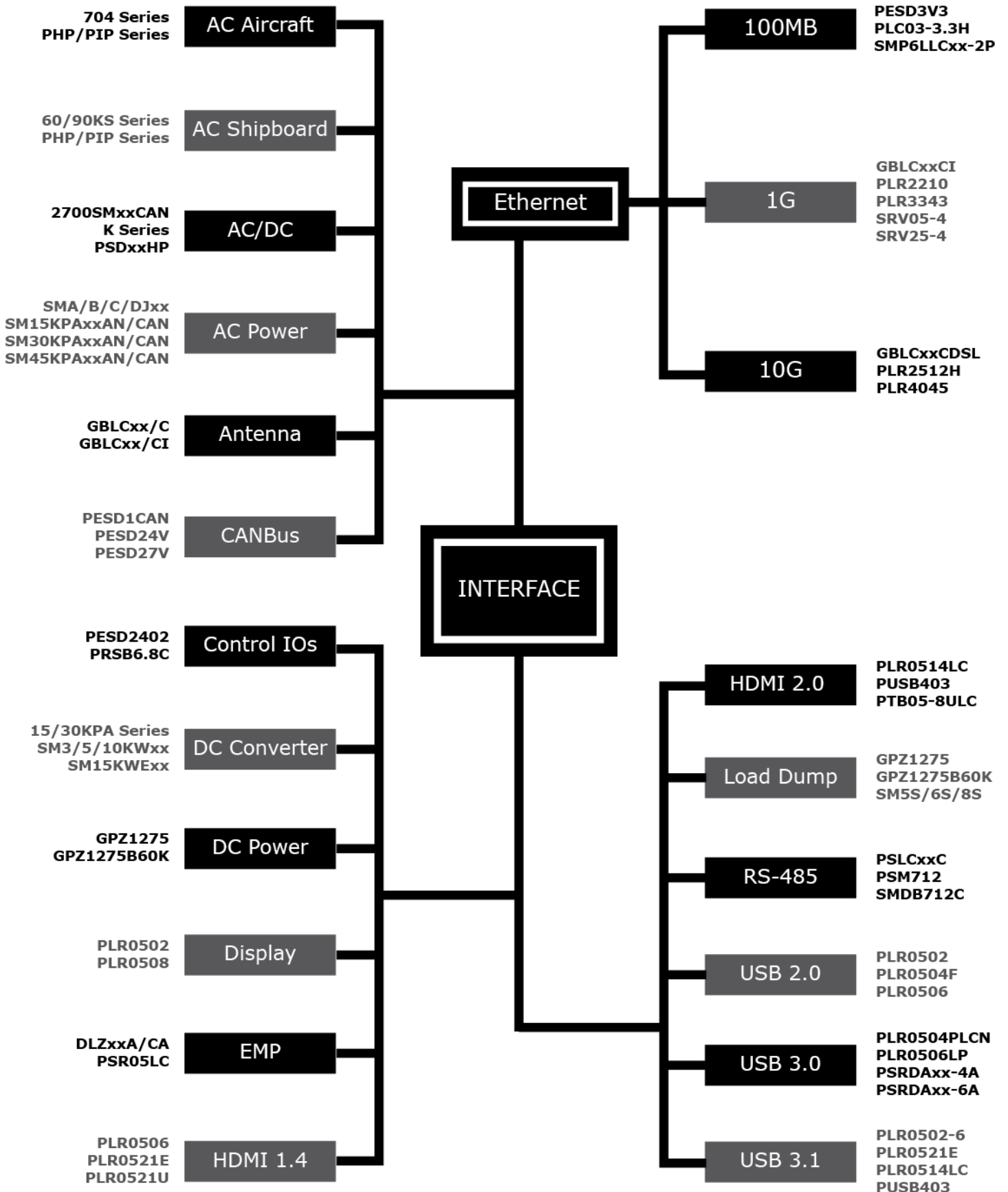

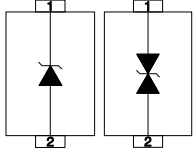
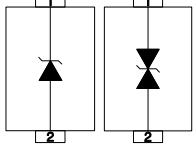
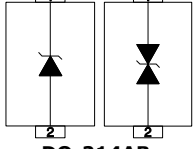
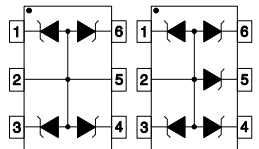
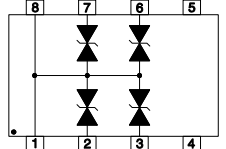
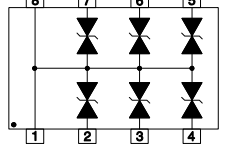
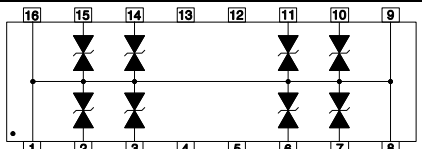
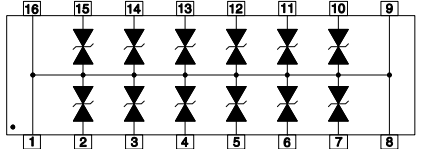
TVS DIODE ARRAYS										
PART NUMBER	STAND-OFF VOLTAGE - V_{WM}	MIN. BREAKDOWN VOLTAGE - V_{BR}	CLAMPING VOLTAGE - $V_C @ I_{PP}$	CURRENT I_{PP} @ 8/20 μ s - A	LEAKAGE CURRENT - μ A @ V_{WM}	CAPACITANCE C_j - pF	NUMBER OF LINES	POWER @ 8/20 μ s - WATTS	PIN CONFIGURATION	
1.0SMBJ5.0A	5.0	6.40	9.2	108.7	200	-	1	1000	 <p>DO-214AA</p>	
Not all voltages are shown for the 1.0SMBJ Series. Please consult the factory for other voltages.										
1.0SMBJ200A	200.0	224.0	324.0	3.1	1	-	1	1000		
Note: I_{PP} and P_{PP} 10/1000 μ s. Part numbers shown are unidirectional. Add a "C" suffix to specify bidirectional devices, such as '1.0SMBJ15CA'.										
1.5SMC6.8A	5.8	6.45	10.5	144.8	1000	-	1	1500	 <p>DO-214AB</p>	
Not all voltages are shown for the 1.5SMC Series. Please consult the factory for other voltages.										
1.5SMC550A	495.0	522.5	760.0	2.0	1	-	1	1500		
Note: I_{PP} and P_{PP} 10/1000 μ s. Part numbers shown are unidirectional. Add a "C" suffix to specify bidirectional devices, such as '1.5SMC6.8CA'.										
5.0SMDJ6.0CA	6.0	6.67	10.3	485	2000	-	1	5000	 <p>DO-214AB</p>	
Not all voltages are shown for the 5.0SMDJ Series. Please consult the factory for other voltages.										
5.0SMDJ440A	440.0	492.0	713.0	7.0	5	-	1	5000		
Note: I_{PP} and P_{PP} 10/1000 μ s. Part numbers shown are unidirectional. Add a "C" suffix to specify bidirectional devices, such as '5.0SMDJ440CA'.										
CP05	5.0	6.0	9.8	1.0	20	70	4-5	200	 <p>SOT-23-6</p>	
CP12	12.0	13.3	19.0	1.0	1	50	4-5	200		
CP15	15.0	16.7	24.0	1.0	1	30	4-5	200		
CP24	24.0	26.7	43.0	1.0	1	25	4-5	200		
Note: Part numbers shown are unidirectional. Add a "C" suffix to specify bidirectional devices, such as 'CP05C'.										
DA05CL	5.0	6.0	24.6	45.0	200	500	4	800	 <p>8 PIN DIP</p>	
DA12CL	12.0	13.3	32.9	34.0	2	385	4	800		
DA15CL	15.0	16.7	37.7	27.0	2	300	4	800		
DA24CL	24.0	26.7	53.0	20.0	2	200	4	800		
DA05CM	5.0	6.0	24.6	45.0	200	500	6	800	 <p>8 PIN DIP</p>	
DA12CM	12.0	13.3	32.9	34.0	2	385	6	800		
DA15CM	15.0	16.7	37.7	27.0	2	300	6	800		
DA24CM	24.0	26.7	53.0	20.0	2	200	6	800		
DA05CN	5.0	6.0	24.6	45.0	200	500	8	800	 <p>16 PIN DIP</p>	
DA12CN	12.0	13.3	32.9	34.0	2	385	8	800		
DA15CN	15.0	16.7	37.7	27.0	2	300	8	800		
DA24CN	24.0	26.7	53.0	20.0	2	200	8	800		
DA05CP	5.0	6.0	24.6	45.0	200	500	12	800	 <p>16 PIN DIP</p>	
DA12CP	12.0	13.3	32.9	34.0	2	385	12	800		
DA15CP	15.0	16.7	37.7	27.0	2	300	12	800		
DA24CP	24.0	26.7	53.0	20.0	2	200	12	800		

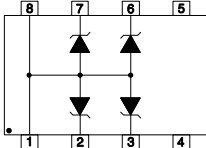
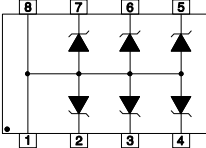
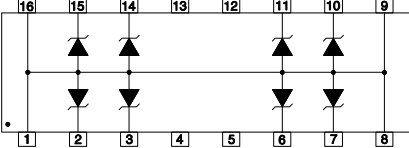
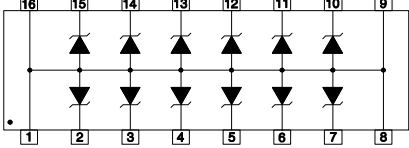
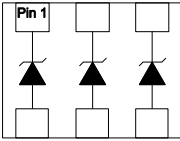
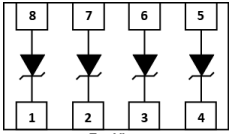
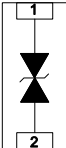
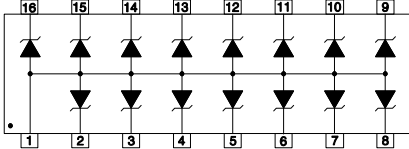
TVS DIODE ARRAYS									
PART NUMBER	STAND-OFF VOLTAGE - V_{WM}	MIN. BREAKDOWN VOLTAGE - V_{BR}	CLAMPING VOLTAGE - $V_C @ I_{PP}$	CURRENT I_{PP} @ 8/20 μ s - A	LEAKAGE CURRENT - μ A @ V_{WM}	CAPACITANCE C_j - pF	NUMBER OF LINES	POWER @ 8/20 μ s - WATTS	PIN CONFIGURATION
DA05L	5.0	6.0	24.6	45.0	200	880	4	800	 <p>8 PIN DIP</p>
DA12L	12.0	13.3	32.9	34.0	2	440	4	800	
DA15L	15.0	16.7	37.7	27.0	2	400	4	800	
DA24L	24.0	26.7	53.0	20.0	2	275	4	800	
DA05M	5.0	6.0	24.6	45.0	200	880	6	800	 <p>8 PIN DIP</p>
DA12M	12.0	13.3	32.9	34.0	2	440	6	800	
DA15M	15.0	16.7	37.7	27.0	2	400	6	800	
DA24M	24.0	26.7	53.0	20.0	2	275	6	800	
DA05N	5.0	6.0	24.6	45.0	200	880	8	800	 <p>16 PIN DIP</p>
DA12N	12.0	13.3	32.9	34.0	2	440	8	800	
DA15N	15.0	16.7	37.7	27.0	2	400	8	800	
DA24N	24.0	26.7	53.0	20.0	2	275	8	800	
DA05P	5.0	6.0	24.6	45.0	200	880	12	800	 <p>16 PIN DIP</p>
DA12P	12.0	13.3	32.9	34.0	2	440	12	800	
DA15P	15.0	16.7	37.7	27.0	2	400	12	800	
DA24P	24.0	26.7	53.0	20.0	2	275	12	800	
DFN6-36	33.0	35.0	45.0	2.0	5	50	3	300	 <p>Top View DFN-6</p>
DFN8-36	33.0	35.0	45.0	2.0	5	50	4	300	 <p>Top View DFN-8</p>
DL0521P	5.0	6.0	20	1.0	1	0.6	1	20	 <p>DFN-2-0402</p>
DLZ-5	5.0	6.0	12.5	10.0	200	880	15	1300	 <p>16 PIN DIP CERAMIC</p>
DLZ-5A	5.0	6.0	10.6	10.0	200	880	15	1300	
DLZ-12	12.0	13.3	26.0	10.0	2	440	15	1300	
DLZ-12A	12.0	13.3	23.5	10.0	2	440	15	1300	
DLZ-17	17.0	19.2	37.4	10.0	2	330	15	1300	
DLZ-17A	17.0	19.2	33.9	10.0	2	330	15	1300	
DLZ-24	24.0	26.7	52.1	10.0	2	275	15	1300	
DLZ-24A	24.0	26.7	47.2	10.0	2	275	15	1300	
DLZ-30	30.0	33.3	65.0	10.0	2	220	15	1300	
DLZ-30A	30.0	33.3	58.8	10.0	2	220	15	1300	

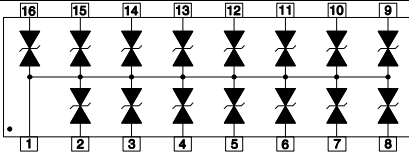
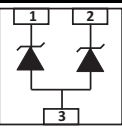
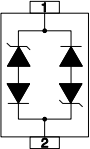
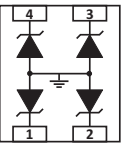
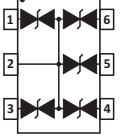
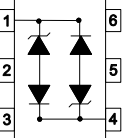
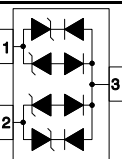
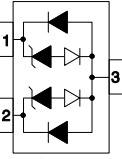
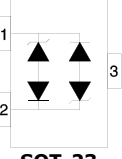
TVS DIODE ARRAYS									
PART NUMBER	STAND-OFF VOLTAGE - V_{WM}	MIN. BREAKDOWN VOLTAGE - V_{BR}	CLAMPING VOLTAGE - $V_C @ I_{PP}$	CURRENT I_{PP} @ 8/20 μ s - A	LEAKAGE CURRENT - μ A @ V_{WM}	CAPACITANCE C_j - pF	NUMBER OF LINES	POWER @ 8/20 μ s - WATTS	PIN CONFIGURATION
DLZ-8C	8.0	8.5	16.6	10.0	10	440	15	1300	 <p>16 PIN DIP CERAMIC</p>
DLZ-13C	13.0	14.4	28.1	10.0	4	385	15	1300	
DLZ-13CA	13.0	14.4	25.4	10.0	4	385	15	1300	
DLZ-19C	19.0	21.6	42.1	10.0	4	275	15	1300	
DLZ-19CA	19.0	21.6	38.1	10.0	4	275	15	1300	
DLZ-30C	30.0	33.3	65.0	10.0	4	165	15	1300	
DLZ-30CA	30.0	33.3	58.8	10.0	4	165	15	1300	
Note: The DLZ Series is not ROHS Compliant.									
DSOT0502	5.0	6.0	12.5	2.0	2	9	1	25	 <p>SOT-883</p>
EBLC05C	5.0	6.0	18.3	17.0	5	3	1	250	 <p>SOD-323</p>
EBLC08C	8.0	8.5	28.0	12.0	2	3	1	250	
EBLC12C	12.0	13.3	31.0	8.0	1	3	1	250	
ESD4-DFN	5.0	6.0	12.0	1.0	0.1 @ 3V	7 @ 2.5V	4	25	 <p>DFN-4</p>
ESDA05C-5	5.0	6.1	-	-	1	15	5	80	 <p>SOT-23-6</p>
ESOT12LCC-1	12.0	13.3	19.0	1.0	1	3	2	250	 <p>SOT-23-6</p>
ESOT24LCC-2	24.0	26.6	-	-	1	6	2	100	 <p>SOT-23</p>
ESOT3.3LC-2	3.3	3.5	6.5	1.0	2	15	2	175	 <p>SOT-23</p>
ESOT3.3LCC	3.3	3.6	-	-	2	15	1	50	 <p>SOT-23</p>

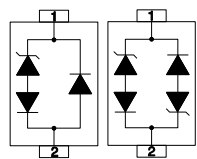
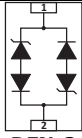
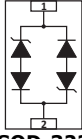
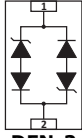
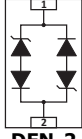
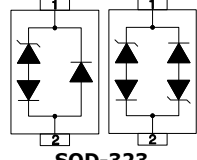
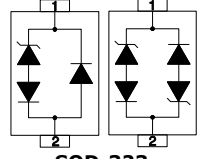
TVS DIODE ARRAYS									
PART NUMBER	STAND-OFF VOLTAGE - V_{WM}	MIN. BREAKDOWN VOLTAGE - V_{BR}	CLAMPING VOLTAGE - $V_C @ I_{PP}$	CURRENT I_{PP} @ 8/20 μ s - A	LEAKAGE CURRENT - μ A @ V_{WM}	CAPACITANCE C_j - pF	NUMBER OF LINES	POWER @ 8/20 μ s - WATTS	PIN CONFIGURATION
GBLC03	3.3	4.0	7.0	1.0	5	3	1	350	 <p>SOD-323</p>
GBLC05	5.0	6.0	9.8	1.0	5	3	1	350	
GBLC08	8.0	8.5	13.4	1.0	2	3	1	350	
GBLC12	12.0	13.3	19.0	1.0	1	3	1	350	
GBLC15	15.0	16.7	24.0	1.0	1	3	1	350	
GBLC18	18.0	20.0	29.0	1.0	1	3	1	350	
GBLC24	24.0	26.7	43.0	1.0	1	3	1	350	
Note: Part numbers shown are unidirectional. Add a "C" suffix to specify bidirectional devices, such as 'GBLC05C'.									
GBLC05CDN	5.0	6.0	18.3	17.0	5	3	1	350	 <p>DFN-2</p>
GBLC08CDN	8.0	8.5	18.5	17.0	2	3	1	350	
GBLC12CDN	12.0	13.3	26.5	11.0	1	3	1	350	
GBLC15CDN	15.0	16.7	31.8	10.0	1	3	1	350	
GBLC24CDN	24.0	26.7	56.0	6.0	1	3	1	350	
GBLC12CDSL	12.0	13.3	19.0	1.0	1	3	1	350	 <p>SOD-323</p>
GBLC24CDSL	24.0	26.7	43.0	1.0	1	3	1	350	
GBLC03CIDFN	3.0	4.0	7.0	1.0	1	0.6	1	250	 <p>DFN-2</p>
GBLC05CIDFN	5.0	6.1	8.0	1.0	5	0.6	1	250	
GBLC03CIDNHP	3.0	4.0	24.0	20.0	5	0.6	1	500	 <p>SOD-323</p>
GBLC03CIHP	3.0	4.0	24.0	20.0	5	0.6	1	500	
GBLC03I	3.0	4.0	7.0	1.0	5	0.6	1	250	 <p>SOD-323</p>
GBLC05I	5.0	6.0	9.8	1.0	5	0.6	1	250	
GBLC08I	8.0	8.5	13.4	1.0	2	0.6	1	250	
GBLC12I	12.0	13.3	19.0	1.0	1	0.6	1	250	
GBLC15I	15.0	16.7	24.0	1.0	1	0.6	1	250	
GBLC18I	18.0	20.0	29.0	1.0	1	0.6	1	250	
GBLC24I	24.0	26.7	43.0	1.0	1	0.6	1	250	
Note: Part numbers shown are unidirectional. Add a "C" suffix to specify bidirectional devices, such as 'GBLC05CI'.									
GBLC03LC	3.3	4.0	7.0	1.0	1	0.8	1	250	 <p>SOD-323</p>
GBLC05LC	5.0	6.0	9.8	1.0	5	0.7	1	250	
Note: Part numbers shown are unidirectional. Add a "C" suffix to specify bidirectional devices, such as 'GBLC05CLC'.									

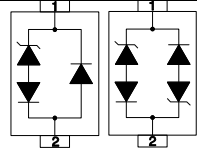
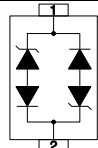
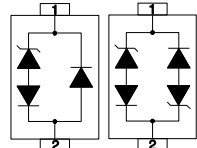
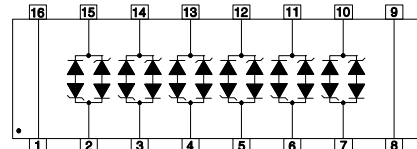
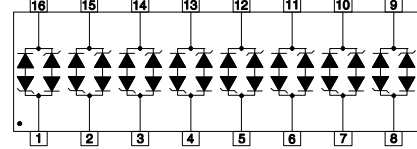
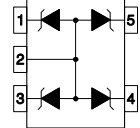
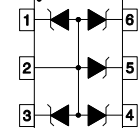
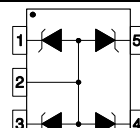
TVS DIODE ARRAYS									
PART NUMBER	STAND-OFF VOLTAGE - V_{WM}	MIN. BREAKDOWN VOLTAGE - V_{BR}	CLAMPING VOLTAGE - $V_C @ I_{PP}$	CURRENT I_{PP} @ 8/20 μ s - A	LEAKAGE CURRENT - μ A @ V_{WM}	CAPACITANCE C_j - pF	NUMBER OF LINES	POWER @ 8/20 μ s - WATTS	PIN CONFIGURATION
GBLCSC03	3.3	4.0	13.0	10.0	1	1.5	1	200	 <p style="text-align: center;">SC-79</p>
GBLCSC05	5.0	6.0	16.0	10.0	1	1.5	1	200	
GBLCSC08	8.0	8.5	-	-	1	1.5	1	200	
GBLCSC12	12.0	13.3	-	-	1	1.5	1	200	
Note: Part numbers shown are unidirectional. Add a "C" suffix to specify bidirectional devices, such as 'GBLCSC05C'.									
GBLCSC08CLC	8.0	8.5	13.0	1.0	1	0.4	1	125	 <p style="text-align: center;">SC-79</p>
GBLLC03	3.0	4.0	7.0	1.0	1	0.4	1	200	 <p style="text-align: center;">SOD-323</p>
Note: Part numbers shown are unidirectional. Add a "C" suffix to specify bidirectional devices, such as 'GBLLC03C'.									
LCA05C	5.0	6.0	24.0	45.0	100	15	6	800	 <p style="text-align: center;">16 PIN DIP</p>
LCA08C	8.0	8.5	25.5	40.0	10	15	6	800	
LCA12C	12.0	13.3	32.0	34.0	4	15	6	800	
LCA15C	15.0	16.7	38.0	27.0	4	15	6	800	
LCA24C	24.0	26.7	48.0	22.0	4	15	6	800	
LCD05C	5.0	6.0	24.0	45.0	100	15	8	800	 <p style="text-align: center;">16 PIN DIP</p>
LCD08C	8.0	8.5	25.5	40.0	10	15	8	800	
LCD12C	12.0	13.3	32.0	34.0	4	15	8	800	
LCD15C	15.0	16.7	38.0	27.0	4	15	8	800	
LCD24C	24.0	26.7	48.0	22.0	4	15	8	800	
MSMF05	5.0	6.0	12.0	9.0	1	40	3-4	100	 <p style="text-align: center;">SOT-553</p>
MSMF12	12.0	13.3	23.8	4.2	1	20	3-4	100	
MSMF15	15.0	16.7	33.3	3.0	1	15	3-4	100	
MSMF24	24.0	26.7	55.5	1.8	1	10	3-4	100	
MSMF05C	5.0	6.0	12.0	9.0	1	40	4-5	100	 <p style="text-align: center;">SOT-563</p>
MSMF12C	12.0	13.3	23.8	4.2	1	20	4-5	100	
MSMF15C	15.0	16.7	33.3	3.0	1	15	4-5	100	
MSMF24C	24.0	26.7	55.5	1.8	1	10	4-5	100	
MSMF05LC	5.0	6.0	12.0	2.0	1	9	3-4	25	 <p style="text-align: center;">SOT-553</p>
Note: Also available in SOT-953 package configuration, part number VSMF05LC									

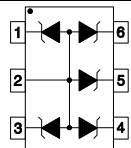
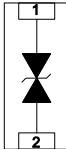
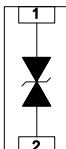
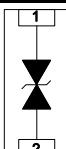
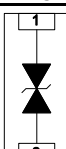
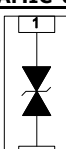
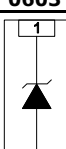
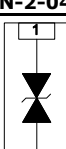
TVS DIODE ARRAYS									
PART NUMBER	STAND-OFF VOLTAGE - V_{WM}	MIN. BREAKDOWN VOLTAGE - V_{BR}	CLAMPING VOLTAGE - $V_C @ I_{PP}$	CURRENT I_{PP} @ 8/20 μ s - A	LEAKAGE CURRENT - μ A @ V_{WM}	CAPACITANCE C_j - pF	NUMBER OF LINES	POWER @ 8/20 μ s - WATTS	PIN CONFIGURATION
MSMF05LCC	5.0	6.0	12.0	2	1	9	4-5	25	 SOT-563
Note: Also available in SOT-963 package configuration, part number VSMF05LCC									
P0201D05C	4.7	5.7	16.0	1.0	0.1	5	1	10	 DFN-2-0201
P0201V05	5.0	-	40.0	-	0.10	0.15	1	-	 CERAMIC-0201
P0402V05	5.0	-	35.0	-	0.10	0.15	1	-	 CERAMIC-0402
P0402V15	15.0	-	35.0	-	0.10	0.05	1	-	
P0402VP24	24.0	-	20.0	-	0.10	0.05	1	-	 CERAMIC-0402
P0603V24	24.0	-	35.0	-	0.10	0.05	1	-	 0603
P5V0S1UL	5.0	6.0	9.8	1.0	1	70	1	150	 DFN-2-0402
P5V0S1ULC	5.0	6.0	9.8	1.0	1	30	1	110	 DFN-2-0402

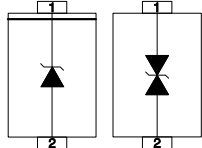
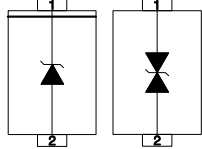
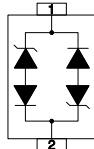
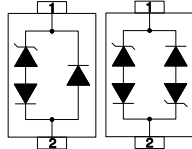
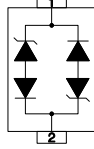
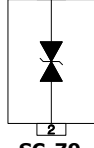
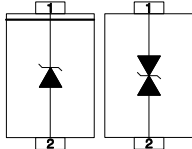
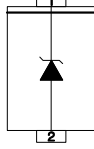
TVS DIODE ARRAYS										
PART NUMBER	STAND-OFF VOLTAGE - V_{WM}	MIN. BREAKDOWN VOLTAGE - V_{BR}	CLAMPING VOLTAGE - $V_C @ I_{PP}$	CURRENT I_{PP} @ 8/20 μ s - A	LEAKAGE CURRENT - μ A @ V_{WM}	CAPACITANCE C_j - pF	NUMBER OF LINES	POWER @ 8/20 μ s - WATTS	PIN CONFIGURATION	
P4SMA130A	111.0	124.0	179.0	2.3	1	-	1	400	 <p>DO-214AC</p>	
Not all voltages are shown for the P4SMA Series. Please consult the factory for other voltages.										
P4SMA400A	342.0	380.0	548.0	0.8	1	-	1	400		
Note: I_{PP} and P_{PP} @ 10/1000 μ s. Part numbers shown are unidirectional. Add a "C" suffix to specify bidirectional device, such as 'P4SMA350CA'.										
P6SMB6.8A	5.8	6.46	10.5	57.14	1000	-	1	600	 <p>DO-214AA</p>	
Not all voltages are shown for the P6SMB Series. Please consult the factory for other voltages.										
P6SMB600A	513	570	828.0	0.72	1	-	1	600		
Note: I_{PP} and P_{PP} @ 10/1000 μ s. Part numbers shown are unidirectional. Add a "C" suffix to specify bidirectional device, such as 'P6SMB6.8CA'.										
PAM01SC7905C	5.0	6.0	16.0	10.0	1	1.5	1	200	 <p>SC-79</p>	
PAM02SD2303C	3.3	4.0	7.0	1.0	5	3	1	350	 <p>SOD-323</p>	
PAM02SD2305C	5.0	6.0	9.8	1.0	5	3	1	350		
PAM02SD2308C	8.0	8.5	13.4	1.0	2	3	1	350		
PAM02SD2312	12.0	13.3	19.0	1.0	1	3	1	350		
PAM02SD2312C	12.0	13.3	19.0	1.0	1	3	1	350		
PAM02SD2315C	15.0	16.7	24.0	1.0	1	3	1	350		
PAM02SD2318C	18.0	20.0	29.0	1.0	1	3	1	350		
PAM02SD2324C	24.0	26.7	43.0	1.0	1	3	1	350		
PAM03SD2303CI	3.0	4.0	7.0	1.0	5	0.6	1	250	 <p>SOD-323</p>	
PAM03SD2312CI	12.0	13.3	19.0	1.0	1	0.6	1	250		
PAM03SD2318CI	18.0	20.0	29.0	1.0	1	0.6	1	250		
PAM06SC7905S	4.7	5.7	-	-	0.5	30	1	10	 <p>SC-79</p>	
Not: I_{PP} and P_{PP} @ 10/1000 μ s, Leakage Current - V_{WM} @ 3.5V										
PAM08SD2303	3.3	4.0	6.5	1.0	125	500	1	500	 <p>SOD-323</p>	
PAM08SD2303C	3.3	4.0	7.0	1.0	125	200	1	400		
PAM08SD2305C	5.0	6.0	9.8	1.0	10	175	1	400		
PAM05SD2308C	8.0	8.5	13.4	1.0	10	150	1	400		
PAM08SD2312C	12.0	13.3	19.0	1.0	1	50	1	400		
PAM08SD2315	15.0	16.7	24.0	1.0	1	100	1	500		
PAM08SD2324C	24.0	26.7	43.0	1.0	1	40	1	400		
PAM08SD2336C	36.0	40.0	60.0	1.0	1	35	1	400		
PAM09SD2305HP	5.0	6.0	15.0	72.0	20	800	1	1000	 <p>SOD-323</p>	

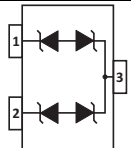
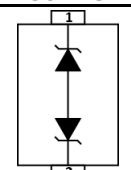
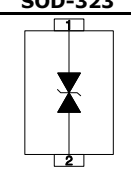
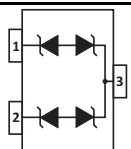
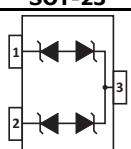
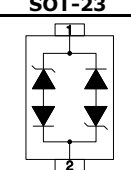
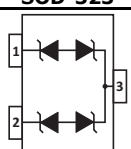
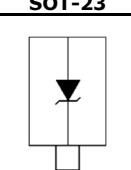
TVS DIODE ARRAYS									
PART NUMBER	STAND-OFF VOLTAGE - V_{WM}	MIN. BREAKDOWN VOLTAGE - V_{BR}	CLAMPING VOLTAGE - $V_C @ I_{PP}$	CURRENT I_{PP} @ 8/20 μ s - A	LEAKAGE CURRENT - μ A @ V_{WM}	CAPACITANCE C_j - pF	NUMBER OF LINES	POWER @ 8/20 μ s - WATTS	PIN CONFIGURATION
PAM1CAN	24.0	25.4	70.0	3.0	0.05	11	2	200	 SOT-23
PAM1FLEX	24.0	25.4	70.0	3.0	0.05	11	2	200	
PAM1IVN27	27.0	28.0	45.0	3.0	0.8	15	1	135	 SOD-323
PAM1LIN PIN 1 - 2	15.0	17.2	44.0	5.0	0.045	17	1	200	 SOD-323
PIN 2 - 1	24.0	25.5	70.0	3.0	0.045	17	1	200	
PAM2CAN	24.0	25.4	60.0	4.0	0.05	11	2	230	 SOT-23
PAM2IVN24	24.0	25.5	42.0	3.5	10	20	2	150	 SOT-23
PAM2LIN	24.0	26.7	43.0	1.0	0.001	3	2	200	 SOD-323
PAM3CAN	24.0	25.4	70.0	2.1	0.002	5	2	150	 SOT-23
PAM5S14A	14.0	15.6	23.2	155	10	-	1	3600	 DO-218AB
Not all voltages are shown for the PAM5S Series. Please consult the factory for other voltages.									
PAM5S36A	36.0	40.0	58.1	62	10	-	1	3600	
Note: I_{PP} and P_{PP} @ 10/1000 μ s.									

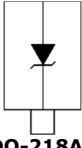
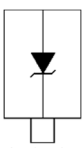
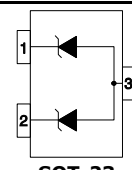
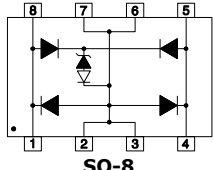
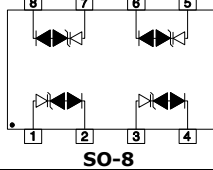
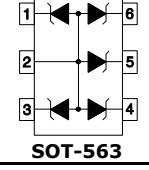
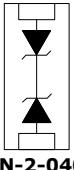
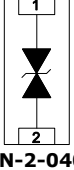

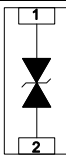
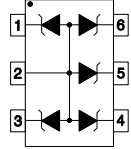
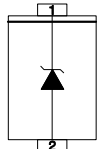
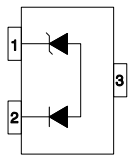
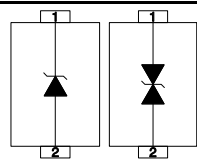
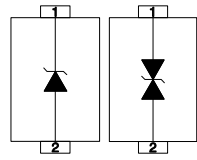
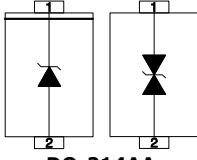
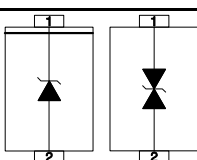
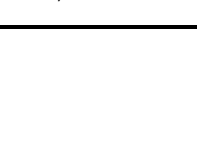
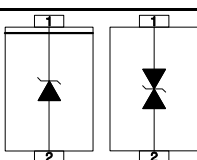
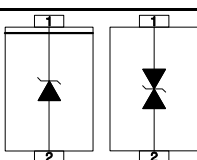
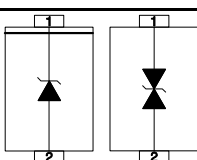

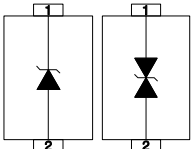
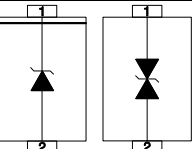
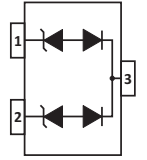
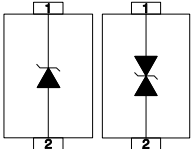
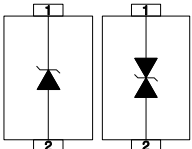
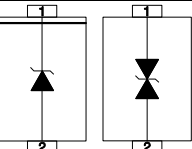
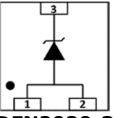
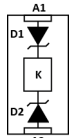
TVS DIODE ARRAYS									
PART NUMBER	STAND-OFF VOLTAGE - V_{WM}	MIN. BREAKDOWN VOLTAGE - V_{BR}	CLAMPING VOLTAGE - $V_C @ I_{PP}$	CURRENT I_{PP} @ 8/20 μ s - A	LEAKAGE CURRENT - μ A @ V_{WM}	CAPACITANCE C_j - pF	NUMBER OF LINES	POWER @ 8/20 μ s - WATTS	PIN CONFIGURATION
PAM6S14A	14.0	15.6	23.2	198	10	-	1	4600	 <p>DO-218AB</p>
Not all voltages are shown for the PAM6S Series. Please consult the factory for other voltages.									
PAM6S36A	36.0	40.0	58.1	79	10	-	1	4600	
Note: I_{PP} and P_{PP} @ 10/1000μs.									
PAM8S14A	14.0	15.6	23.2	284	10	-	1	6600	 <p>DO-218AB</p>
Not all voltages are shown for the PAM8S Series. Please consult the factory for other voltages.									
PAM8S48A	48.0	53.3	85.2	77.4	10	-	1	6600	
Note: I_{PP} and P_{PP} @ 10/1000μs.									
PAM10ST2303C	3.3	4.0	10.9	43.0	125	300	1	500	 <p>SOT-23</p>
PAM10ST2308C	8.0	8.5	16.9	34.0	10	150	1	500	
PAM10ST2315C	15.0	16.7	30.0	17.0	1	60	1	500	
PAM10ST2324C	24.0	26.7	49.0	12.0	1	63	1	500	
PAM10ST2336C	36.0	40.0	76.8	9.0	1	60	1	500	
PAM11SO803	3.0	2.8	18.0	100.0	2	25	1	1800	 <p>SO-8</p>
PAM12SO824	2.8	3.0	21.0	30.0	1	3	2P	600	 <p>SO-8</p>
PAM14ST6305LCC	5.0	6.0	12.0	2.0	1	9	4-5	25	 <p>SOT-563</p>
PAM17DF2L05C	4.7	5.7	-	-	1	15	1	10	 <p>DFN-2-0402</p>
Note: I_{PP} and P_{PP} at 10/1000μs.									
PAM18DF2L0521	5.0	6.0	20.0	3.0	1	0.4	1	80	 <p>DFN-2-0402</p>

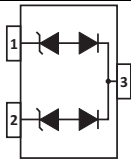
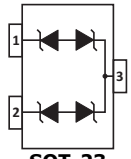
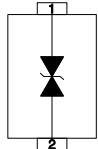
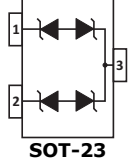
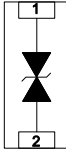
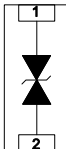
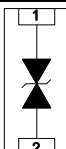
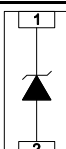
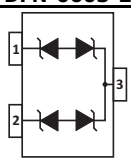
TVS DIODE ARRAYS									
PART NUMBER	STAND-OFF VOLTAGE - V_{WM}	MIN. BREAKDOWN VOLTAGE - V_{BR}	CLAMPING VOLTAGE - $V_C @ I_{PP}$	CURRENT I_{PP} @ 8/20 μ s - A	LEAKAGE CURRENT - μ A @ V_{WM}	CAPACITANCE C_j - pF	NUMBER OF LINES	POWER @ 8/20 μ s - WATTS	PIN CONFIGURATION
PAM19DF2L0521P	5.0	6.0	20.0	1.0	1	0.6	1	20	 DFN-2-0402
PAM20ST6305	5.0	6.0	12.0	9.0	1	40	4-5	100	 SOT-563
PAM21SC790501H	5.0	6.0	12.5	16.0	5	120	1	250	 SC-79
PAM27ST2324LC	24.0	26.7	46.0	5.0	1	5	1	500	 SOT-23
PAM28DOAC6.5A	6.5	7.22	11.2	35.7	500	-	1	400	 DO-214AC
Not all voltages are shown for the PAM28DOAC Series. Please consult the factory for other voltages.									
PAM28DOAC120A	120.0	133.0	193.0	2.1	1	-	1	400	 DO-214AA
Note: I_{PP} and P_{PP} 10/1000 μ s. Part numbers shown are unidirectional. Add a "C" suffix to specify bidirectional device, such as 'PAM28DOAC12CA'.									
PAM29DOAA5.0A	5.0	6.40	9.2	65.2	800	-	1	600	 DO-214AA
Not all voltages are shown for the PAM29DOAA Series. Please consult the factory for other voltages.									
PAM29DOAA180A	180.0	200.0	291.6	2.1	1	-	1	600	 DO-214AA
Note: I_{PP} and P_{PP} 10/1000 μ s. Part numbers shown are unidirectional. Add a "C" suffix to specify bidirectional device, such as 'PAM29DOAA26CA'.									
PAM30DOAA6.8A	5.8	6.46	10.5	57.14	1000	-	1	600	 DO-214AA
Not all voltages are shown for the PAM30DOAA Series. Please consult the factory for other voltages.									
PAM30DOAA600A	513	570	828.0	0.72	1	-	1	600	 DO-214AB
Note: I_{PP} and P_{PP} @ 10/1000 μ s. Part numbers shown are unidirectional. Add a "C" suffix to specify bidirectional device, such as 'PAM30DOAA6.8CA'.									
PAM31DOAB18A	18.0	20.0	29.2	51.4	1	-	1	1500	 DO-214AB
Not all voltages are shown for the PAM31DOAB Series. Please consult the factory for other voltages.									
PAM31DOAB120A	120.0	133.0	193.0	7.8	1	-	1	1500	 DO-214AB
Note: I_{PP} and P_{PP} @ 10/1000 μ s. Part numbers shown are unidirectional. Add a "C" suffix to specify bidirectional device, such as 'PAM31DOAB18CA'.									

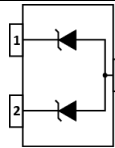
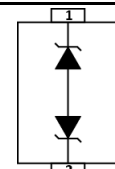
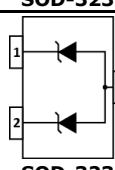
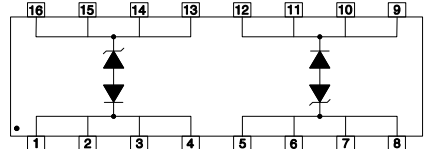
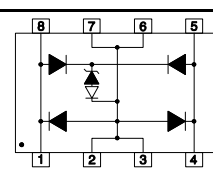
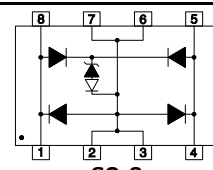
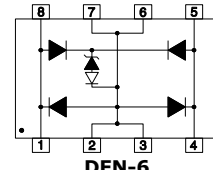
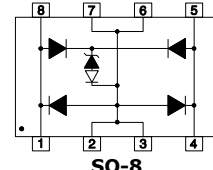

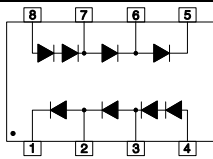
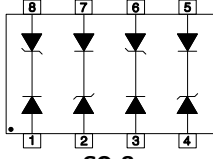
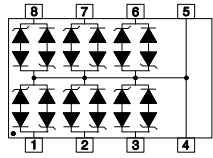
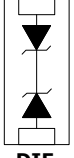
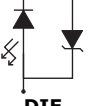
TVS DIODE ARRAYS										
PART NUMBER	STAND-OFF VOLTAGE - V_{WM}	MIN. BREAKDOWN VOLTAGE - V_{BR}	CLAMPING VOLTAGE - $V_C @ I_{PP}$	CURRENT I_{PP} @ 8/20 μ s - A	LEAKAGE CURRENT - μ A @ V_{WM}	CAPACITANCE C_j - pF	NUMBER OF LINES	POWER @ 8/20 μ s - WATTS	PIN CONFIGURATION	
PAM32DOAB20A	20.0	22.2	32.4	92.5	2	-	1	3000	 <p>DO-214AB</p>	
PAM32DOAB22A	22.0	24.4	35.5	84.5	2	-	1	3000		
PAM32DOAB28A	28.0	31.1	45.4	66.1	2	-	1	3000		
PAM32DOAB36A	36.0	40.0	58.1	51.6	2	-	1	3000		
Note: I_{PP} and P_{PP} @ 10/1000 μ s. Part numbers shown are unidirectional. Add a "C" suffix to specify bidirectional device, such as 'PAM32DOAB36CA'.										
PAM33DOAB18A	18.0	20.0	29.2	173	10	-	1	5000	 <p>DO-214AB</p>	
Not all voltages are shown for the PAM33DOAB Series. Please consult the factory for other voltages.										
PAM33DOAB180A	180.0	200.0	291.6	17.3	5	-	1	5000		
Note: I_{PP} and P_{PP} @ 10/1000 μ s. Part numbers shown are unidirectional. Add a "C" suffix to specify bidirectional device, such as 'PAM33DOAB18A'.										
PAM34ST2305	5.0	6.0	9.8	1.0	5	0.8	1	-	 <p>SOT-23</p>	
PAM35DOAB30A	25.6	28.5	41.4	36.7	1	-	1	1500	 <p>DO-214AB</p>	
PAM35DOAB47A	40.2	44.7	64.8	23.5	1	-	1	1500		
PAM35DOAB75A	64.2	71.3	103.0	14.8	1	-	1	1500		
PAM33DOAB300A	256.0	285.0	414.0	3.7	1	-	1	1500		
Note: I_{PP} and P_{PP} @ 10/1000 μ s. Part numbers shown are unidirectional. Add a "C" suffix to specify bidirectional device, such as 'PAM35DOAB75CA'.										
PAM36DOAA33A	33.0	36.70	53.3	18.8	1	-	1	1000	 <p>DO-214AA</p>	
Note: I_{PP} and P_{PP} @ 10/1000 μ s. Part numbers shown are unidirectional. Add a "C" suffix to specify bidirectional device, such as 'PAM36DOAA33CA'.										
PAM37SD6.0AL	6.0	6.67	10.3	35.9	120	-	1	400	 <p>SOD-123FL</p>	
Not all voltages are shown for the PAM37SDxxAL Series. Please consult the factory for other voltages.										
PAM37SD58AL	58.0	64.4	93.6	4.3	1	-	1	400		
Note: I_{PP} and P_{PP} @ 10/1000 μ s. Part numbers shown are unidirectional. Add a "C" suffix to specify bidirectional device, such as 'PAM37SD12CAL'.										
PDFN2-32	32.0	34.0	55.0	25.0	5	-	1	1400	 <p>DFN2020-3</p>	
PDFN3-32	32.0	34.0	55.0	25.0	0.2	-	1	2800	 <p>DFN-3</p>	

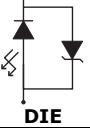
TVS DIODE ARRAYS									
PART NUMBER	STAND-OFF VOLTAGE - V_{WM}	MIN. BREAKDOWN VOLTAGE - V_{BR}	CLAMPING VOLTAGE - $V_C @ I_{PP}$	CURRENT I_{PP} @ 8/20 μ s - A	LEAKAGE CURRENT - μ A @ V_{WM}	CAPACITANCE C_J - pF	NUMBER OF LINES	POWER @ 8/20 μ s - WATTS	PIN CONFIGURATION
PDLC05	5.0	6.0	9.8	1.0	5	0.8	1	-	 <p>SOT-23</p>
PESD1CAN	24.0	25.4	70.0	3.0	0.05	11	2	200	 <p>SOT-23</p>
PESD1FLEX	24.0	25.4	70.0	3.0	0.05	11	2	200	
PESD1LIN PIN 1 - 2	15.0	17.2	44.0	5.0	0.045	17	1	200	 <p>SOD-323</p>
PIN 2 - 1	24.0	25.5	70.0	3.0	0.045	17	1	200	
PESD2CAN	24.0	25.4	60.0	4.0	0.05	11	2	230	 <p>SOT-23</p>
PESD05B	5.0	5.6	9.5	4.0	1	10	1	40	 <p>DFN-0603-2</p>
PESD05BLC	5.0	7.0	9.5	3.0	1	0.42	1	40	 <p>DFN-0603-2</p>
PESD12LCB	12.0	14.0	27	4	1	8	1	90	 <p>DFN-1006-2</p>
PESD12ULC	12.0	14.5	23	3.5	1	15.5	1	70	 <p>DFN-0603-2</p>
PESD24V	24.0	25.5	42.0	3.5	0.8	20	1	150	 <p>SOT-23</p>

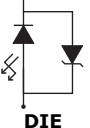
TVS DIODE ARRAYS									
PART NUMBER	STAND-OFF VOLTAGE - V_{WM}	MIN. BREAKDOWN VOLTAGE - V_{BR}	CLAMPING VOLTAGE - $V_C @ I_{PP}$	CURRENT I_{PP} @ 8/20 μ s - A	LEAKAGE CURRENT - μ A @ V_{WM}	CAPACITANCE C_j - pF	NUMBER OF LINES	POWER @ 8/20 μ s - WATTS	PIN CONFIGURATION
PESD2402	24.0	25.4	-	-	0.5	22	2	100	 <p>SOT-23</p>
PESD27V	27.0	28.0	45.0	3.0	0.10	15	1	135	 <p>SOD-323</p>
PESD3V3	3.3	5.2	20.0	20.0	2	20	1	400	 <p>SOD-323</p>
PLC01-6	6.0	8.0	16.0	200.0	25	50	1	1500	 <p>SO-16(WIDE BODY)</p>
Note: I_{PP} & P_{PP} @ 10/1000μs									
PLC03-3.3	3.0	2.8	22.0	150.0	2	25	1	3300	 <p>SO-8</p>
PLC03-3.3H	3.0	2.8	25.0	240.0	2	25	1	6000	 <p>SO-8</p>
PLC03-3.3-DFN	3.0	2.8	18.0	100.0	2	25	1	1800	 <p>DFN-6</p>
PLC03-3.3LC	3.0	2.8	18.0	100.0	2	6	1	1800	 <p>SO-8</p>
PLC03-6LC	6.0	6.8	20.0	90.0	2.5	6	1	1800	

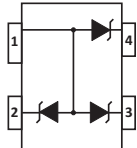
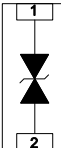
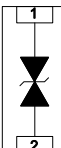
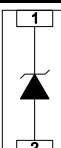
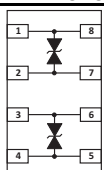
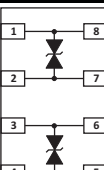
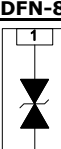
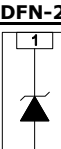
TVS DIODE ARRAYS									
PART NUMBER	STAND-OFF VOLTAGE - V_{WM}	MIN. BREAKDOWN VOLTAGE - V_{BR}	CLAMPING VOLTAGE - $V_C @ I_{PP}$	CURRENT I_{PP} @ 8/20 μ s - A	LEAKAGE CURRENT - μ A @ V_{WM}	CAPACITANCE C_j - pF	NUMBER OF LINES	POWER @ 8/20 μ s - WATTS	PIN CONFIGURATION
PLC496	1.0	2.5	12.5	30.0	1	1.25	1	500	 SO-8
PLCDA03	3.3	4.5	7.0	1.0	125	5	2	500	 SO-8
PLCDA05	5.0	6.0	9.8	1.0	20	5	2	500	
PLCDA08	8.0	8.5	13.4	1.0	10	5	2	500	
PLCDA12	12.0	13.3	19.0	1.0	1	5	2	500	
PLCDA15	15.0	16.7	24.0	1.0	1	5	2	500	
PLCDA24	24.0	26.7	43.0	1.0	1	5	2	500	
PLCDA03C-6	3.3	4.5	7.0	1.0	125	8	6	500	 SO-8
PLCDA05C-6	5.0	6.0	9.8	1.0	20	8	6	500	
PLCDA08C-6	8.0	8.5	13.4	1.0	10	8	6	500	
PLCDA12C-6	12.0	13.3	19.0	1.0	2	8	6	500	
PLCDA15C-6	15.0	16.7	24.0	1.0	2	8	6	500	
PLED05F189	5.0	6.0	-	-	10	10	1	-	 DIE
PLED0811PU	8.0	8.5	-	-	1	70	1	-	 DIE
PLED3631X23NB	36.0	40.0	-	-	1	60	-	-	 DIE
PLED508	4.7	5.7	-	-	1	15	-	-	 DIE
PLED508U	5.0	6.0	-	-	0.1	80	-	-	 DIE
PLED511	4.7	5.7	13.0	1.0	1	15	-	-	 DIE
PLED511U	5.0	6.0	-	-	0.5	80	-	-	 DIE

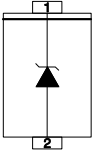
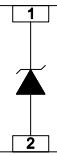
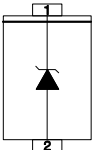
TVS DIODE ARRAYS									
PART NUMBER	STAND-OFF VOLTAGE - V_{WM}	MIN. BREAKDOWN VOLTAGE - $V_{(BR)}$	CLAMPING VOLTAGE - $V_c @ I_{PP}$	CURRENT I_{PP} @ 8/20 μ s - A	LEAKAGE CURRENT - μ A @ V_{WM}	CAPACITANCE C_j - pF	NUMBER OF LINES	POWER @ 8/20 μ s - WATTS	PIN CONFIGURATION
PLR0503	5.0	6.0	12.5	2.0	1	9	1	25	 <p>SOT-143</p>
PLR0521	5.0	6.0	20.0	4.0	1	0.4	1	80	 <p>DFN-2-0402</p>
PLR0521E	5.0	6.0	20.0	4.0	1	0.4	1	80	 <p>DFN-2-0402</p>
PLR0521U	5.0	6.0	20.0	4.0	1	0.8	1	80	 <p>DFN-2-0402</p>
PLR2512H	2.5	2.7	8.0	10.0	0.05	3	2P	100	 <p>DFN-8</p>
PLR2512	2.5	2.7	10.2	10.0	0.05	3	2P	100	 <p>DFN-8</p>
PLR3312	3.3	3.5	11.0	10.0	0.05	3	2P	100	
PLR3311	3.3	3.3	8.0	5.0	0.05	5	1	40	 <p>DFN-2</p>
PLW0501D	5.0	6.0	9.8	1.0	1	70	1	150	 <p>DFN-2-0402</p>

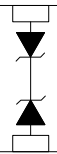
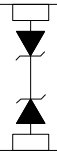
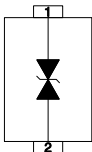
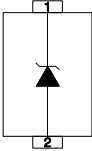
TVS DIODE ARRAYS									
PART NUMBER	STAND-OFF VOLTAGE - V_{WM}	MIN. BREAKDOWN VOLTAGE - V_{BR}	CLAMPING VOLTAGE - $V_C @ I_{PP}$	CURRENT I_{PP} @ 8/20 μ s - A	LEAKAGE CURRENT - μ A @ V_{WM}	CAPACITANCE C_j - pF	NUMBER OF LINES	POWER @ 8/20 μ s - WATTS	PIN CONFIGURATION
PLW0501H	5.0	6.0	12.5	16.0	5	120	1	250	 SC-79
PLW0501P	5.0	6.0	12.5	16.0	5	120	1	250	 DFN-2-0402
PLW1201H	12.0	13.3	24.0	5.0	1	50	1	200	 SC-79
PLW2.8	2.8	3.0	5.0	1.0	1	6	1	50	 SC-79
PRSB6.8C	4.7	5.7	17.5	3.0	0.5	15	1	50	 DFN-2-0402
PRSB6.8CT	4.7	5.7	-	-	1	15	1	10	 DFN-2-0402
Note: I_{PP} & P_{PP} @ 10/1000μs.									
PRSB6.8D	4.7	5.7	-	-	1	15	1	10	 SOD-923
Note: I_{PP} & P_{PP} @ 10/1000μs.									
PSD03	3.3	4.0	6.5	1.0	125	500	1	500	 SOD-323
PSD05	5.0	6.0	9.8	1.0	10	350	1	500	
PSD08	8.0	8.5	13.4	1.0	10	250	1	500	
PSD12	12.0	13.3	19.0	1.0	1	150	1	500	
PSD15	15.0	16.7	24.0	1.0	1	100	1	500	
PSD18	18.0	20.0	29.0	1.0	1	90	1	500	
PSD24	24.0	26.7	43.0	1.0	1	88	1	500	
PSD36	36.0	40.0	60.0	1.0	1	75	1	500	

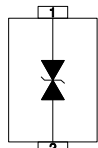
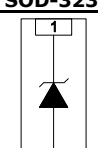
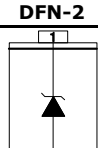
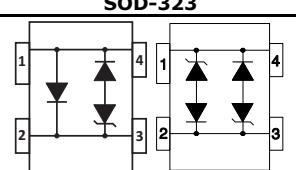
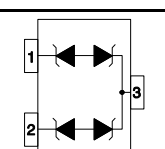
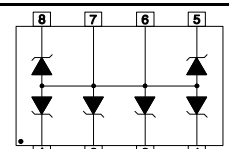
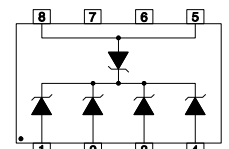
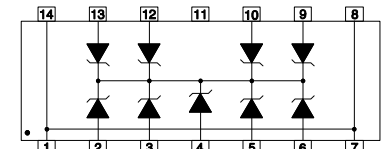
TVS DIODE ARRAYS									
PART NUMBER	STAND-OFF VOLTAGE - V_{WM}	MIN. BREAKDOWN VOLTAGE - V_{BR}	CLAMPING VOLTAGE - $V_c @ I_{PP}$	CURRENT I_{PP} @ 8/20 μ s - A	LEAKAGE CURRENT - μ A @ V_{WM}	CAPACITANCE C_j - pF	NUMBER OF LINES	POWER @ 8/20 μ s - WATTS	PIN CONFIGURATION
PSD03C	3.3	4.0	7.0	1.0	125	200	1	400	 <p>SOD-323</p>
PSD05C	5.0	6.0	9.8	1.0	10	175	1	400	
PSD08C	8.0	8.5	13.4	1.0	10	150	1	400	
PSD12C	12.0	13.3	19.0	1.0	1	50	1	400	
PSD15C	15.0	16.7	24.0	1.0	1	40	1	400	
PSD18C	18.0	20.0	29.0	1.0	1	40	1	400	
PSD24C	24.0	26.7	43.0	1.0	1	40	1	400	
PSD36C	36.0	40.0	60.0	1.0	1	35	1	400	
PSD0561	5.0	6.0	16.0	90.0	0.3	800	1	1400	 <p>DFN-2</p>
PSD3261	32.0	34.0	60.0	25.0	0.2	300	1	1400	
PSD05HP	5.0	6.0	15.0	72.0	20	800	1	1000	 <p>SOD-323</p>
PSD10HP	10.0	11.0	25.0	45.0	2	500	1	1000	
PSD12HP	12.0	13.3	32.0	34.0	2	440	1	1000	
PSLC03	3.3	4.0	19.0	20.0	125	3	1	350	 <p>SOT-143</p>
PSLC05	5.0	6.0	18.3	17.0	20	3	1	350	
PSLC08	8.0	8.5	18.5	17.0	10	3	1	350	
PSLC12	12.0	13.3	28.6	11.0	1	3	1	350	
PSLC15	15.0	16.6	31.8	10.0	1	3	1	350	
PSLC24	24.0	26.7	56.0	6.0	1	3	1	350	
Note: Part numbers shown are unidirectional. Add a "C" suffix to specify bidirectional devices, such as 'PSLC05C'.									
PSM712 Pin 3-1, 3-2 Pin 1-3, 2-3	7.0 12.0	7.5 13.3	17.0 30.0	34.0 30.0	20 1	75 75	1 1	600 600	 <p>SOT-23</p>
PSMDA05-6	5.0	6.0	18.0	17.0	20	120	5-6	350	 <p>SO-8</p>
PSMDA05C-4	5.0	6.0	19.0	30.0	100	350	4	500	 <p>SO-8</p>
PSMDA12C-4	12.0	13.3	29.0	20.0	1	150	4	500	
PSMDA15C-4	15.0	16.7	32.0	18.0	1	120	4	500	
PSMDA24C-4	24.0	26.7	45.0	13.0	1	100	4	500	
PSMDA05C-8	5.0	6.0	15.4	30.0	100	350	8	450	 <p>SO-14</p>
PSMDA12C-8	12.0	13.4	26.4	17.0	1	150	8	450	
PSMDA15C-8	15.0	16.7	32.4	14.0	1	120	8	450	
PSMDA24C-8	24.0	26.7	45.0	10.0	1	100	8	450	

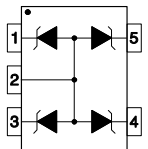
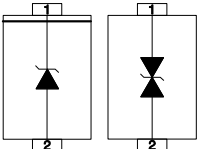
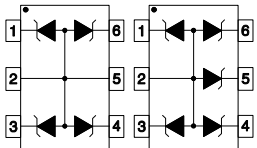
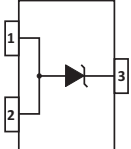
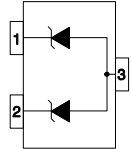
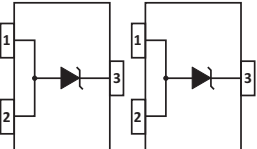
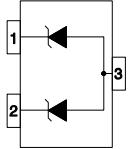
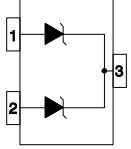
TVS DIODE ARRAYS									
PART NUMBER	STAND-OFF VOLTAGE - V_{WM}	MIN. BREAKDOWN VOLTAGE - V_{BR}	CLAMPING VOLTAGE - $V_c @ I_{PP}$	CURRENT I_{PP} @ 8/20 μ s - A	LEAKAGE CURRENT - μ A @ V_{WM}	CAPACITANCE C_j - pF	NUMBER OF LINES	POWER @ 8/20 μ s - WATTS	PIN CONFIGURATION
PSMF05	5.0	6.0	9.5	1.0	10	60	4	100	 SC70-5L
PSMF6.0AL	6.0	6.67	10.3	35.9	120	-	1	400	<p>Not all voltages are shown for the PSMFxxAL Series. Please consult the factory for other voltages.</p>  SOD-123FL
PSMF58AL	58.0	64.4	93.6	4.3	1	-	1	400	
Note: I_{PP} and P_{PP} @ 10/1000 μ s. Part numbers shown are unidirectional. Add a "C" suffix to specify bidirectional device, such as 'PSMF12CAL'.									
PSMS05	5.0	6.0	9.8	1.0	20	150	4-5	350	 SOT-23-6
PSMS12	12.0	13.3	19.0	1.0	1	80	4-5	350	
PSMS15	15.0	16.7	24.0	1.0	1	50	4-5	350	
PSMS24	24.0	26.7	40.0	1.0	1	40	4-5	350	
Note: Part numbers shown are unidirectional. Add a "C" suffix to specify bidirectional devices, such as 'PSMS05C'. PSMS05/C Series are identical to SMS05/C Series.									
PSOT03	3.3	4.0	10.9	43.0	125	500	1	500	 SOT-23
PSOT05	5.0	6.0	13.5	42.0	20	350	1	500	
PSOT08	8.0	8.5	16.9	34.0	10	250	1	500	
PSOT12	12.0	13.3	25.9	21.0	2	150	1	500	
PSOT15	15.0	16.7	30.0	17.0	1	100	1	500	
PSOT24	24.0	26.7	49.0	12.0	1	88	1	500	
PSOT36	36.0	40.0	76.8	9.0	1	80	1	500	
PSOT03C	3.3	4.0	10.9	43.0	125	300	1	500	 SOT-23
PSOT05C	5.0	6.0	13.5	42.0	20	210	1	500	
PSOT08C	8.0	8.5	16.9	34.0	10	150	1	500	
PSOT12C	12.0	13.3	25.9	21.0	2	90	1	500	
PSOT15C	15.0	16.7	30.0	17.0	1	60	1	500	
PSOT24C	24.0	26.7	49.0	12.0	1	63	1	500	
PSOT36C	36.0	40.0	76.8	9.0	1	60	1	500	
PSOT053	5.0	6.0	19.0	16.0	20	350	1	300	 SOT-23
PSOT123	12.0	13.3	28.0	11.0	1	150	1	300	
PSOT153	15.0	16.7	30.0	10.0	1	100	1	300	
PSOT243	24.0	26.7	50.0	6.0	1	88	1	300	
PSOT053C	5.0	6.0	19.0	16.0	20	210	1	300	
PSOT123C	12.0	13.3	28.0	11.0	1	90	1	300	
PSOT153C	15.0	16.7	30.0	10.0	1	60	1	300	
PSOT243C	24.0	26.7	50.0	6.0	1	63	1	300	
PSOT05CLP	5.0	6.0	9.8	1.0	10	210	1	300	 SOT-23
PSOT15KCA	12.8	14.3	33.0	9.0	0.1	120	2	300	 SOT-23
PSOT36KCA	33.0	36.0	66.0	6.0	0.1	45	2	300	

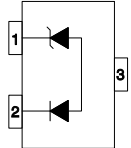
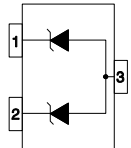
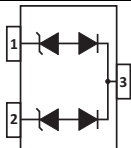
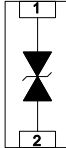
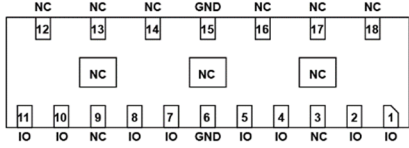
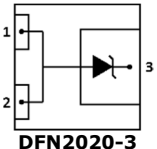
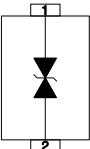
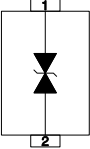
TVS DIODE ARRAYS									
PART NUMBER	STAND-OFF VOLTAGE - V_{WM}	MIN. BREAKDOWN VOLTAGE - V_{BR}	CLAMPING VOLTAGE - $V_C @ I_{PP}$	CURRENT I_{PP} @ 8/20 μ s - A	LEAKAGE CURRENT - μ A @ V_{WM}	CAPACITANCE C_j - pF	NUMBER OF LINES	POWER @ 8/20 μ s - WATTS	PIN CONFIGURATION
PSOT03LC	3.3	4.0	9.0	5.0	125	5	1	500	 <p>SOT-23</p>
PSOT05LC	5.0	6.0	11.0	5.0	20	5	1	500	
PSOT08LC	8.0	8.5	15.0	5.0	10	5	1	500	
PSOT12LC	12.0	13.3	23.0	5.0	1	5	1	500	
PSOT15LC	15.0	16.7	28.0	5.0	1	5	1	500	
PSOT24LC	24.0	26.7	46.0	5.0	1	5	1	500	
PSOT36LC	36.0	40.0	68.0	5.0	1	5	1	500	
PSOT05LCC	5.0	6.0	15.0	20.0	10	120	1-2	300	 <p>SOT-23</p>
PSOT05ULC	5.0	6.0	9.8	1.0	5	0.8	2	250	 <p>SOT-23</p>
PSSB05P	5.0	6.0	20.0	1.0	1	0.3	1	20	 <p>DFN-2-0402</p>
PTB05-8ULC	5.0	5.5	11.5	5	1	0.15	8	-	 <p>DFN-18</p>
PTVS5.0A	5.0	6.2	14.7	204	2000	-	1	3000	 <p>DFN2020-3</p>
PTVS7.5A	7.0	8.0	19.0	200	1000	-	1	3000	
PTVS10A	10.0	11.10	23.0	148	50	-	1	3000	
PTVS12A	12.0	13.30	25.2	131	50	-	1	3000	
PTVS15A	15.0	16.70	28.8	111	50	-	1	3000	
PTVS18A	18.0	20.00	32.0	97	50	-	1	3000	
PTVS24A	24.0	25.5	43.5	69	50	-	1	3000	
RSB6.8B	4.7	5.7	-	-	0.5	30	1	10	 <p>SOD-323</p>
Note: I_{PP} and P_{PP} @ 10/1000 μ s, Leakage Current - V_{WM} @ 3.5V									
RSB6.8G	4.7	5.7	-	-	0.5	15	1	10	 <p>SOD-723</p>
Note: I_{PP} and P_{PP} @ 10/1000 μ s, Leakage Current - V_{WM} @ 3.5V									

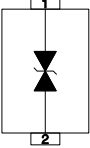
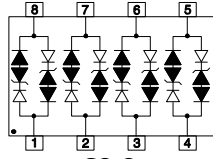
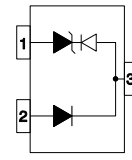
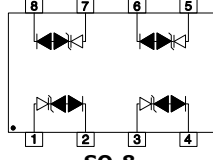
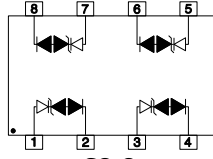
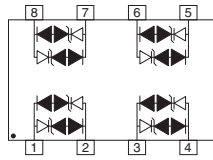
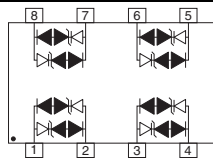
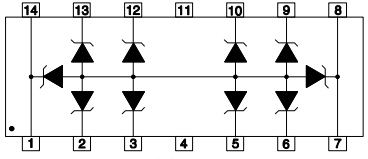
TVS DIODE ARRAYS									
PART NUMBER	STAND-OFF VOLTAGE - V_{WM}	MIN. BREAKDOWN VOLTAGE - V_{BR}	CLAMPING VOLTAGE - V_C @ I_{PP}	CURRENT I_{PP} @ 8/20 μ s - A	LEAKAGE CURRENT - μ A @ V_{WM}	CAPACITANCE C_j - pF	NUMBER OF LINES	POWER @ 8/20 μ s - WATTS	PIN CONFIGURATION
RSB6.8S	4.7	5.7	-	-	0.5	30	1	10	 <p>SC-79</p>
Not: I_{PP} and P_{PP} @ 10/1000μs, Leakage Current - V_{WM} @ 3.5V									
SLVDA2.8LC	2.8	3.0	21.0	30.0	1	5	4P	600	 <p>SO-8</p>
SLVU2.8	2.8	3.0	21.0	30.0	1	2.5	1	600	 <p>SOT-23</p>
SLVU2.8-4	2.8	3.0	21.0	30.0	1	3	2P	600	 <p>SO-8</p>
SLVU2.8-4G	2.8	3.0	18.0	24.0	0.1	2	2P	600	 <p>SO-8</p>
SLVU2.8-8	2.8	3.0	17.0	30.0	1	6.0	4P	600	 <p>SO-8</p>
SLVU2.8-8G	2.8	3.0	17.0	30.0	1	3.7	4P	500	 <p>SO-8</p>
SM14M05C	5.0	6.0	17.8	47.0	100	500	8	800	 <p>SO-14</p>
SM14M08C	8.0	8.5	20.1	40.0	10	440	8	800	
SM14M12C	12.0	13.3	26.6	34.0	2	385	8	800	
SM14M15C	15.0	16.7	33.1	25.0	2	300	8	800	
SM14M24C	24.0	26.7	42.1	19.0	2	200	8	800	

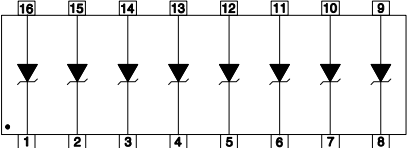
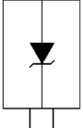
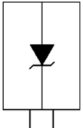
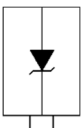
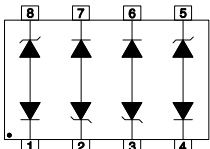
TVS DIODE ARRAYS									
PART NUMBER	STAND-OFF VOLTAGE - V_{WM}	MIN. BREAKDOWN VOLTAGE - V_{BR}	CLAMPING VOLTAGE - $V_C @ I_{PP}$	CURRENT I_{PP} @ 8/20 μ s - A	LEAKAGE CURRENT - μ A @ V_{WM}	CAPACITANCE C_j - pF	NUMBER OF LINES	POWER @ 8/20 μ s - WATTS	PIN CONFIGURATION
SM1603	3.3	4.0	10.9	43.0	125	800	8	500	 <p>SO-16</p>
SM1605	5.0	6.0	13.5	42.0	10	550	8	500	
SM1608	8.0	8.5	16.9	34.0	10	500	8	500	
SM1612	12.0	13.4	25.9	21.0	2	185	8	500	
SM1615	15.0	16.7	30.0	17.0	2	140	8	500	
SM1624	24.0	26.7	49.0	12.0	2	88	8	500	
SM1603C	3.3	4.0	10.9	43.0	125	450	8	500	
SM1605C	5.0	6.0	13.5	42.0	10	310	8	500	
SM1608C	8.0	8.5	16.9	34.0	10	280	8	500	
SM1612C	12.0	13.4	25.9	21.0	2	105	8	500	
SM1615C	15.0	16.7	30.0	17.0	2	80	8	500	
SM1624C	24.0	26.7	49.0	12.0	2	50	8	500	
SM16LC03	3.3	4.5	20.0	35.0	125	15	8	500	
SM16LC05	5.0	6.0	24.0	42.0	20	15	8	500	
SM16LC08	8.0	8.5	26.0	30.0	10	15	8	500	
SM16LC12	12.0	13.3	33.0	21.0	2	15	8	500	
SM16LC15	15.0	16.7	39.0	15.0	2	15	8	500	
SM16LC24	24.0	26.7	57.0	10.0	2	15	8	500	
SM16LC36	36.0	40.0	72.0	7.0	2	15	8	500	
SM16LC03C	3.3	4.5	20.0	35.0	125	15	8	500	
SM16LC05C	5.0	6.0	24.0	42.0	20	15	8	500	
SM16LC08C	8.0	8.5	26.0	30.0	10	15	8	500	
SM16LC12C	12.0	13.3	33.0	21.0	2	15	8	500	
SM16LC15C	15.0	16.7	39.0	15.0	2	15	8	500	
SM16LC24C	24.0	26.7	57.0	10.0	2	15	8	500	
SM16LC36C	36.0	40.0	72.0	7.0	2	15	8	500	
SM5S14A	14.0	15.6	23.2	155	10	-	1	3600	
<p>Not all voltages are shown for the SM5S Series. Please consult the factory for other voltages.</p>									 <p>DO-218AB</p>
SM5S36A	36.0	40.0	58.1	62	10	-	1	3600	
<p>Note: I_{PP} and P_{PP} @ 10/1000μs.</p>									
SM6S14A	14.0	15.6	23.2	198	10	-	1	4600	
<p>Not all voltages are shown for the SM6S Series. Please consult the factory for other voltages.</p>									 <p>DO-218AB</p>
SM6S36A	36.0	40.0	58.1	79	10	-	1	4600	
<p>Note: I_{PP} and P_{PP} @ 10/1000μs.</p>									
SM8S14A	14.0	15.6	23.2	284	10	-	1	6600	
<p>Not all voltages are shown for the SM8S Series. Please consult the factory for other voltages.</p>									 <p>DO-218AB</p>
SM8S43A	43.0	47.8	69.4	95.1	10	-	1	6600	
<p>Note: I_{PP} and P_{PP} @ 10/1000μs.</p>									
SM8LC05	5.0	6.0	24.6	45.0	100	25	2P	800	
SM8LC08	8.0	8.5	25.5	40.0	10	25	2P	800	
SM8LC12	12.0	13.3	32.9	34.0	4	25	2P	800	
SM8LC15	15.0	16.7	38.5	27.0	4	25	2P	800	
SM8LC24	24.0	26.7	48.5	22.0	4	25	2P	800	
 <p>SO-8</p>									

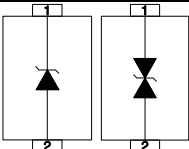
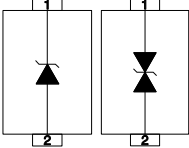
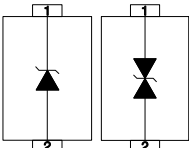
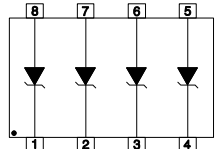
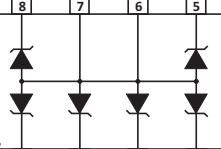
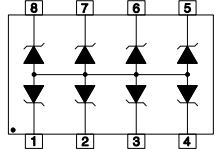
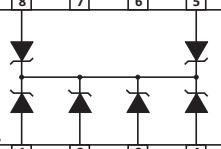
TVS DIODE ARRAYS										
PART NUMBER	STAND-OFF VOLTAGE - V_{WM}	MIN. BREAKDOWN VOLTAGE - V_{BR}	CLAMPING VOLTAGE - $V_C @ I_{PP}$	CURRENT I_{PP} @ 8/20 μ s - A	LEAKAGE CURRENT - μ A @ V_{WM}	CAPACITANCE C_j - pF	NUMBER OF LINES	POWER @ 8/20 μ s - WATTS	PIN CONFIGURATION	
SMAJ5.0	5.0	6.40	9.6	41.7	800	-	1	400	 <p>DO-214AC</p>	
Not all voltages are shown for the SMAJ Series. Please consult the factory for other voltages.										
SMAJ440A	440.0	492.0	713.0	0.6	5	-	1	400		
Note: I_{PP} and P_{PP} 10/1000 μ s. Part numbers shown are unidirectional. Add a "C" suffix to specify bidirectional devices, such as 'SMAJ440CA'.										
SMBJ5.0	5.0	6.40	9.6	62.5	800	-	1	600	 <p>DO-214AA</p>	
Not all voltages are shown for the SMBJ Series. Please consult the factory for other voltages.										
SMBJ480A	480.0	537.0	779.0	0.77	1	-	1	600		
Note: I_{PP} and P_{PP} 10/1000 μ s. Part numbers shown are unidirectional. Add a "C" suffix to specify bidirectional devices, such as 'SMBJ440CA'.										
SMCJ5.0	5.0	6.40	9.6	156	800	-	1	1500	 <p>DO-214AB</p>	
Not all voltages are shown for the SMCJ Series. Please consult the factory for other voltages.										
SMCJ440A	440.0	492.0	713.0	2.1	1	-	1	1500		
Note: I_{PP} and P_{PP} 10/1000 μ s. Part numbers shown are unidirectional. Add a "C" suffix to specify bidirectional devices, such as 'SMCJ440CA'.										
SMDA03	3.3	4.0	7.0	5.0	125	800	4	500	 <p>SO-8</p>	
SMDA05	5.0	6.0	10.0	5.0	20	550	4	500		
SMDA08	8.0	8.5	14.0	5.0	10	500	4	500		
SMDA12	12.0	13.3	22.0	5.0	1	185	4	500		
SMDA15	15.0	16.7	27.0	5.0	1	140	4	500		
SMDA24	24.0	26.7	45.0	5.0	1	88	4	500		
SMDA36	36.0	40.0	65.0	5.0	1	80	4	500		
SMDA03C	3.3	4.5	9.0	5.0	125	450	4	500		
SMDA05C	5.0	6.0	10.0	5.0	20	308	4	500		
SMDA08C	8.0	8.5	14.0	5.0	10	300	4	500		
SMDA12C	12.0	13.3	22.0	5.0	1	105	4	500		
SMDA15C	15.0	16.7	27.0	5.0	1	80	4	500		
SMDA24C	24.0	26.7	45.0	5.0	1	50	4	500		
SMDA36C	36.0	40.0	65.0	5.0	1	45	4	500		
SMDA03-6	3.3	4.0	9.0	5.0	75	300	5-6	300	 <p>SO-8</p>	
SMDA05-6	5.0	6.0	11.0	5.0	20	308	5-6	300		
SMDA12-6	12.0	13.3	24.0	5.0	1	185	5-6	300		
SMDA15-6	15.0	16.7	30.0	5.0	1	140	5-6	300		
SMDA24-6	24.0	26.7	55.0	5.0	1	80	5-6	300		
SMDA05CM	5.0	6.0	19.0	30.0	100	350	4-7	500	 <p>SO-8</p>	
SMDA08CM	8.0	8.5	23.7	24.0	10	300	4-7	500		
SMDA12CM	12.0	13.4	29.2	20.0	1	150	4-7	500		
SMDA15CM	15.0	16.7	31.1	18.0	1	100	4-7	500		
SMDA24CM	24.0	26.7	45.0	13.0	1	63	4-7	500		
SMDA05CN-5	5.0	6.0	19.0	30.0	10	350	5	500	 <p>SO-8</p>	
SMDA12CN-5	12.0	13.4	29.0	20.0	1	150	5	500		
SMDA15CN-5	15.0	16.7	31.0	18.0	1	75	5	500		
SMDA24CN-5	24.0	26.7	45.0	13.0	1	63	5	500		

TVS DIODE ARRAYS									
PART NUMBER	STAND-OFF VOLTAGE - V_{WM}	MIN. BREAKDOWN VOLTAGE - V_{BR}	CLAMPING VOLTAGE - $V_C @ I_{PP}$	CURRENT I_{PP} @ 8/20 μ s - A	LEAKAGE CURRENT - μ A @ V_{WM}	CAPACITANCE C_j - pF	NUMBER OF LINES	POWER @ 8/20 μ s - WATTS	PIN CONFIGURATION
SMDA03LC	3.3	4.5	10.9	43.0	125	15	4	500	<p>SO-8</p>
SMDA05LC	5.0	6.0	13.5	42.0	20	15	4	500	
SMDA08LC	8.0	8.5	16.9	34.0	10	15	4	500	
SMDA12LC	12.0	13.3	25.9	27.0	1	15	4	500	
SMDA15LC	15.0	16.7	30.0	17.0	1	15	4	500	
SMDA24LC	24.0	26.7	49.0	12.0	1	15	4	500	
SMDA03LCC	3.3	4.5	10.9	43.0	125	15	4	500	<p>SO-8</p>
SMDA05LCC	5.0	6.0	13.5	42.0	20	15	4	500	
SMDA08LCC	8.0	8.5	16.9	34.0	10	15	4	500	
SMDA15LCC	15.0	16.7	30.0	17.0	1	15	4	500	
SMDA24LCC	24.0	26.7	49.0	12.0	1	15	4	500	
SMDB05	5.0	6.0	24.6	45.0	25	880	4	800	
SMDB08	8.0	8.5	25.5	40.0	10	800	4	800	
SMDB12	12.0	13.3	32.9	34.0	2	440	4	800	
SMDB15	15.0	16.7	38.5	27.0	2	400	4	800	
SMDB24	24.0	26.7	48.5	20.0	2	275	4	800	<p>SO-8</p>
SMDB05C	5.0	6.0	24.6	45.0	25	493	4	800	
SMDB08C	8.0	8.5	25.5	40.0	10	450	4	800	
SMDB12C	12.0	13.3	32.9	34.0	2	248	4	800	
SMDB15C	15.0	16.7	38.5	27.0	2	225	4	800	<p>SO-8</p>
SMDB24C	24.0	26.7	48.5	20.0	2	155	4	800	
SMDB712C	7.0 12.0	8.5 13.3	25.5 32.9	40.0 34.0	10 2	284	1	800	
SMDJ5.0	5.0	6.40	9.6	313	5000	-	1	3000	
<p>Not all voltages are shown for the SMDJ Series. Please consult the factory for other voltages.</p>									
SMDJ440A	440.0	492.0	713.0	4.2	1	-	1	3000	<p>SC70-6L</p>
<p>Note: I_{PP} and P_{PP} 10/1000μs. Part numbers shown are unidirectional. Add a "C" suffix to specify bidirectional devices, such as 'SMDJ440CA'.</p>									
SMF05C	5.0	6.0	9.8	5.0	5	60	4-5	100	<p>SO-16</p>
SMF12C	12.0	13.3	18.0	5.0	1	30	4-5	100	
SMF15C	15.0	16.7	22.0	5.0	1	25	4-5	100	
SMF24C	24.0	26.7	50.0	5.0	1	20	4-5	100	
SMLC6.5C-2	6.5	7.2	28.0	150.0	300	30	2P	3900	<p>SO-16</p>
SMLC12C-2	12.0	13.3	35.0	140.0	2	30	2P	3900	

TVS DIODE ARRAYS									
PART NUMBER	STAND-OFF VOLTAGE - V_{WM}	MIN. BREAKDOWN VOLTAGE - V_{BR}	CLAMPING VOLTAGE - $V_C @ I_{PP}$	CURRENT I_{PP} @ 8/20 μ s - A	LEAKAGE CURRENT - μ A @ V_{WM}	CAPACITANCE C_j - pF	NUMBER OF LINES	POWER @ 8/20 μ s - WATTS	PIN CONFIGURATION
SMP6LC05-2P	5.0	6.0	26.0	150	300	15	2P	3900	<p>SO-16</p>
SMP6LC6.5-2P	6.5	7.2	28.0	150	300	15	2P	3900	
SMP6LC08-2P	8.0	8.6	30.0	140	25	15	2P	3900	
SMP6LC12-2P	12.0	13.3	35.0	140	2	15	2P	3900	
SMP6LC15-2P	15.0	16.7	50.0	110	2	15	2P	3900	
SMP6LC24-2P	24.0	26.7	57.0	80	2	15	2P	3900	
SMP6LLC05-2P	5.0	6.0	26.0	150.0	300	5	2P	3900	<p>SO-16</p>
SMP6LLC6.5-2P	6.5	7.2	28.0	150.0	300	5	2P	3900	
SMP6LLC12-2P	12.0	13.3	35.0	140.0	2	5	2P	3900	
SMS05	5.0	6.0	9.8	1.0	20	150	4	350	<p>SOT-23-6</p>
SMS12	12.0	13.3	19.0	1.0	1	80	4	350	
SMS15	15.0	16.7	24.0	1.0	1	50	4	350	
SMS24	24.0	26.7	40.0	1.0	1	40	4	350	
Note: Part numbers shown are unidirectional. Add a "C" suffix to specify bidirectional devices, such as 'SMS05C'. PSMSxx/C Series are identical to SMSxx/C Series									
USB0403	3.3	4.0	19.0	20.0	125	5	1	350	<p>SOT-143</p>
USB0405	5.0	6.0	18.3	17.0	20	5	1	350	
USB0408	8.0	8.5	18.5	17.0	10	5	1	350	
USB0412	12.0	13.3	28.6	11.0	1	5	1	350	
USB0415	15.0	16.6	31.8	10.0	1	5	1	350	
USB0424	24.0	26.7	56.0	6.0	1	5	1	350	
Note: Part numbers shown are unidirectional. Add a "C" suffix to specify bidirectional devices, such as 'USB0415C'.									
USB50803	3.3	4.5	11.0	5.0	125	3	1	500	<p>SO-8</p>
USB50805	5.0	6.0	13.0	5.0	20	3	1	500	
USB50812	12.0	13.3	26.0	5.0	1	3	1	500	
USB50815	15.0	16.7	32.0	5.0	1	3	1	500	
USB50824	24.0	26.7	57.0	5.0	1	3	1	500	
USB50803C	3.3	4.5	11.0	5.0	125	3	1	500	<p>SO-8</p>
USB50805C	5.0	6.0	13.0	5.0	20	3	1	500	
USB50812C	12.0	13.3	26.0	5.0	1	3	1	500	
USB50815C	15.0	16.7	32.0	5.0	1	3	1	500	
USB50824C	24.0	26.7	57.0	5.0	1	3	1	500	
VS10P05	5.0	6.0	12.5	10.0	100	880	8	800	<p>10 PIN VSIP</p>
VS10P08	8.0	8.5	16.6	10.0	10	800	8	800	
VS10P12	12.0	13.3	22.7	10.0	1	440	8	800	
VS10P15	15.0	16.7	28.5	10.0	1	-	8	800	
VS10P24	24.0	26.7	45.6	10.0	1	-	8	800	
VS10P05C	5.0	6.0	12.5	10.0	100	500	8	800	<p>10 PIN VSIP</p>
VS10P08C	8.0	8.5	16.6	10.0	10	-	8	800	
VS10P12C	12.0	13.3	22.7	10.0	1	-	8	800	
VS10P15C	15.0	16.7	28.5	10.0	1	-	8	800	
VS10P24C	24.0	26.7	45.6	10.0	1	275	8	800	

TVS DIODE ARRAYS

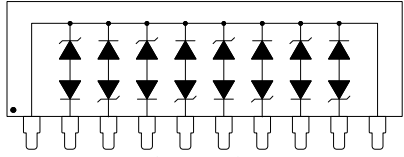
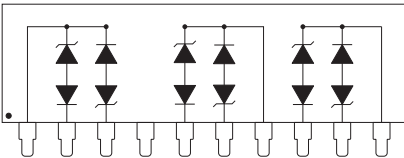
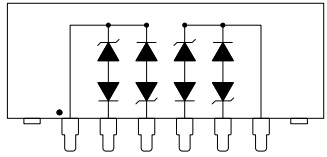
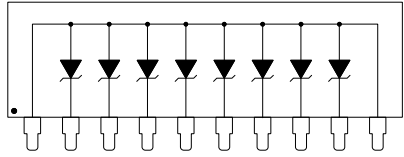
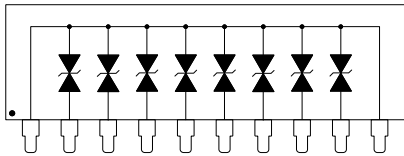
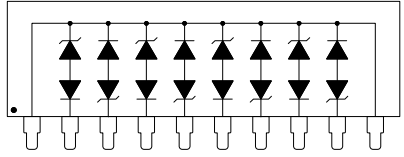
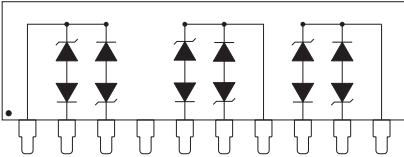
PART NUMBER	STAND-OFF VOLTAGE - V_{WM}	MIN. BREAKDOWN VOLTAGE - V_{BR}	CLAMPING VOLTAGE - $V_C @ I_{PP}$	CURRENT I_{PP} @ 8/20 μ s - A	LEAKAGE CURRENT - μ A @ V_{WM}	CAPACITANCE C_j - pF	NUMBER OF LINES	POWER @ 8/20 μ s - WATTS	PIN CONFIGURATION
VS10P03LC	3.3	4.5	9.0	5.0	125	15	4	300	 <p>10 PIN VSIP</p>
VS10P05LC	5.0	6.0	12.5	10.0	100	25	4	800	
VS10P08LC	8.0	8.5	16.6	10.0	10	25	4	800	
VS10P12LC	12.0	13.3	22.7	10.0	1	25	4	800	
VS10P15LC	15.0	16.7	28.5	10.0	1	25	4	800	
VS10P24LC	24.0	26.7	45.6	10.0	1	25	4	800	
VS10P05LCI	5.0	6.0	12.5	10.0	100	25	3	800	 <p>10 PIN VSIP</p>
VS10P08LCI	8.0	8.5	16.6	10.0	10	25	3	800	
VS10P12LCI	12.0	13.3	22.7	10.0	1	25	3	800	
VS10P15LCI	15.0	16.7	28.5	10.0	1	25	3	800	
VS10P24LCI	24.0	26.7	45.6	10.0	1	25	3	800	
VSB06P05LCI	5.0	6.0	16.5	36.0	300	50	2	600	 <p>6 PIN VSIP</p>
Note: I_{PP} and P_{PP} @ 10/1000μs									
VSB10P05	5.0	6.0	9.1	10.0	300	4000	8	3400	 <p>10 PIN VSIP</p>
VSB10P08	8.0	8.5	12.0	10.0	200	-	8	3400	
VSB10P12	12.0	13.3	18.8	10.0	2	-	8	3400	
VSB10P15	15.0	16.7	23.6	10.0	2	-	8	3400	
VSB10P24	24.0	26.7	37.8	10.0	2	1250	8	3400	
VSB10P28	28.0	31.1	44.0	10.0	2	-	8	3400	
VSB10P33	33.0	36.7	51.9	10.0	2	-	8	3400	
VSB10P36	36.0	40.0	56.6	10.0	2	-	8	3400	
VSB10P05C	5.0	6.0	9.1	10.0	300	2000	8	3400	 <p>10 PIN VSIP</p>
VSB10P08C	8.0	8.5	12.0	10.0	200	-	8	3400	
VSB10P12C	12.0	13.3	18.8	10.0	2	-	8	3400	
VSB10P15C	15.0	16.7	23.6	10.0	2	-	8	3400	
VSB10P24C	24.0	26.7	37.8	10.0	2	1250	8	3400	
VSB10P28C	28.0	31.1	44.0	10.0	2	-	8	3400	
VSB10P33C	33.0	36.7	51.9	10.0	2	400	8	3400	
VSB10P36C	36.0	40.0	56.6	10.0	2	-	8	3400	
VSB10P05LC	5.0	6.0	9.1	10.0	300	100	4P	3400	 <p>10 PIN VSIP</p>
VSB10P08LC	8.0	8.5	12.0	10.0	200	100	4P	3400	
VSB10P12LC	12.0	13.3	18.8	10.0	2	100	4P	3400	
VSB10P15LC	15.0	16.7	23.6	10.0	2	100	4P	3400	
VSB10P24LC	24.0	26.7	37.8	10.0	2	100	4P	3400	
VSB10P28LC	28.0	31.1	44.0	10.0	2	100	4P	3400	
VSB10P33LC	33.0	36.7	51.9	10.0	2	100	4P	3400	
VSB10P36LC	36.0	40.0	56.6	10.0	2	100	4P	3400	
VSB10P05LCI	5.0	6.0	9.1	10.0	300	100	3P	3400	 <p>10 PIN VSIP</p>
VSB10P08LCI	8.0	8.5	12.0	10.0	200	100	3P	3400	
VSB10P12LCI	12.0	13.3	18.8	10.0	2	100	3P	3400	
VSB10P15LCI	15.0	16.7	23.6	10.0	2	100	3P	3400	
VSB10P24LCI	24.0	26.7	37.8	10.0	2	100	3P	3400	
VSB10P28LCI	28.0	31.1	44.0	10.0	2	100	3P	3400	
VSB10P33LCI	33.0	36.7	51.9	10.0	2	100	3P	3400	
VSB10P36LCI	36.0	40.0	56.6	10.0	2	100	3P	3400	

TVS DIODE ARRAYS									
PART NUMBER	STAND-OFF VOLTAGE - V_{WM}	MIN. BREAKDOWN VOLTAGE - V_{BR}	CLAMPING VOLTAGE - $V_C @ I_{PP}$	CURRENT I_{PP} @ 8/20 μ s - A	LEAKAGE CURRENT - μ A @ V_{WM}	CAPACITANCE C_j - pF	NUMBER OF LINES	POWER @ 8/20 μ s - WATTS	PIN CONFIGURATION
VSMF05LC	5.0	6.0	12.0	2.0	1	9	4	25	<p>SOT-953</p>
Note: Also available in SOT-553 package configuration, part number MSMF05LC									
VSMF05LCC	5.0	6.0	12.0	2	1	9	4-5	25	<p>SOT-963</p>
Note: Also available in SOT-563 package configuration, part number MSMF05LC									

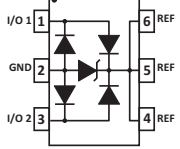
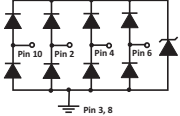
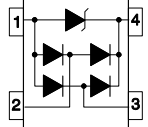
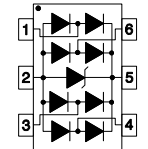
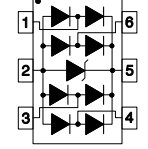
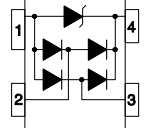
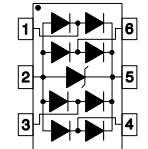
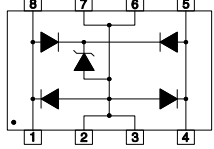
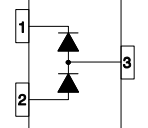
STEERING DIODE/TVS COMBO									
PART NUMBER	STAND-OFF VOLTAGE - V_{WM}	MIN. BREAKDOWN VOLTAGE - V_{BR}	CLAMPING VOLTAGE - $V_c @ I_{PP}$	CURRENT I_{PP} @ 8/20 μ s - A	LEAKAGE CURRENT - μ A @ V_{WM}	CAPACITANCE $C_{i(sD)}$ - pF	NUMBER OF LINES	POWER @ 8/20 μ s - WATTS	PIN CONFIGURATION
DSL03-24	24.0	26.0	55.0	15.0	0.1	5.0	2	500	 <p>SOT-23-6</p>
PAM04DF100524	5.0	6.0	12.0	1.0	0.5	0.7	4	150	 <p>DFN-10</p>
PAM04ST430502	5.0	6.0	20.0	10.0	1	0.6	2	200	 <p>SOT-543</p>
PAM05SC700504F	5.0	6.0	25.0	5.0	3	1.9	4	200	 <p>SC70-6L</p>
PAM13ST2305	5.0	6.0	15.0	5.0	5	3.5	4	500	 <p>SOT-23-6</p>
PAM15ST4305	5.0	6.0	20.0	28.0	5	10	2	500	 <p>SOT-143</p>
PAZC099	5.0	6.0	12.0	1.0	0.5	0.6	4	100	 <p>SOT-23-6</p>
PLC03-6	6.0	6.8	20.0	100.0	25	8	2	2K	 <p>SO-8</p>
PLC497	1.0	1.3	5.0	5.0	20	2.5	1	200	 <p>SOT-23</p>

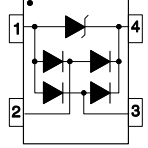
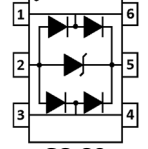
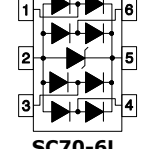
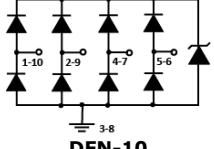
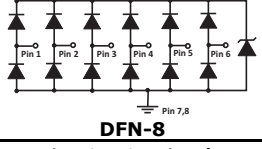
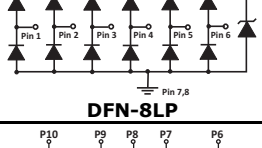
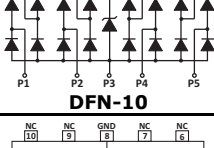
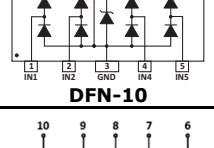
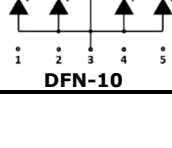
STEERING DIODE/TVS COMBO									
PART NUMBER	STAND-OFF VOLTAGE - V_{WM}	MIN. BREAKDOWN VOLTAGE - V_{BR}	CLAMPING VOLTAGE - $V_c @ I_{PP}$	CURRENT I_{PP} @ 8/20 μ s - A	LEAKAGE CURRENT - μ A @ V_{WM}	CAPACITANCE $C_{J(SD)}$ - pF	NUMBER OF LINES	POWER @ 8/20 μ s - WATTS	PIN CONFIGURATION
PLR0502	5.0	6.0	20.0	10.0	1	0.6	2	200	 <p>SOT-543</p>
PLR0502-6	5.0	6.0	17.0	3.0	1	0.7	2	50	 <p>SC-89</p>
PLR0504F	5.0	6.0	25.0	5.0	3	1.9	4	200	 <p>SC70-6L</p>
PLR0504PLCN	5.0	6.0	15.6	16.0	0.5	1.5	4	250	 <p>DFN-10</p>
PLR0506	5.0	6.0	18.0	4.0	3	0.8	6	72	 <p>DFN-8</p>
PLR0506LP	5.0	6.0	18.0	4.0	3	0.8	6	72	 <p>DFN-8LP</p>
PLR0508	5.0	6.0	13.0	5.0	1	1.6	8	200	 <p>DFN-10</p>
PLR0514LC	5.0	6.0	12.0	1.0	1	0.6	4	-	 <p>DFN-10</p>
PLR05214LC	5.0	6.0	20.0	5.0	0.5	0.35	4	-	 <p>DFN-10</p>

STEERING DIODE/TVS COMBO									
PART NUMBER	STAND-OFF VOLTAGE - V_{WM}	MIN. BREAKDOWN VOLTAGE - V_{BR}	CLAMPING VOLTAGE - $V_c @ I_{PP}$	CURRENT I_{PP} @ 8/20 μ s - A	LEAKAGE CURRENT - μ A @ V_{WM}	CAPACITANCE $C_{j(sD)}$ - pF	NUMBER OF LINES	POWER @ 8/20 μ s - WATTS	PIN CONFIGURATION
PLR0522	5.0	6.0	16.5	4.0	0.5	0.8	2	60	 DFN-6
PLR0524	5.0	6.0	12.0	1.0	0.5	0.7	4	150	 DFN-10
PLR0524P	5.0	6.0	16.5	4.0	0.5	0.8	4	60	 DFN-10
PLR2210	2.5	3.3	11.5	10.0	0.05	0.6	2P	170	 DFN-8
PLR2504	2.5	2.0	7.5	10.0	0.5	4	4P	300	 DFN-10
PLR3304	3.3	3.3	10.0	10.0	0.1	4.0	4	400	 DFN-10
PLR3304PLCN	3.3	4.0	15.0	17.0	0.1	1.5	4	250	 DFN-10
PLR3343	3.3	5.6	10.0	1.0	1	0.25	4	150	 DFN-10
PLR4045	3.3	4.0	20.0	30.0	0.1	1.6	4	600	 MSOP-10

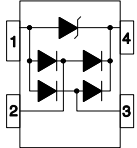
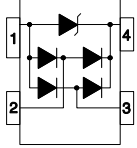
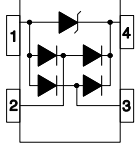
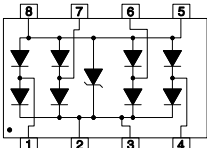
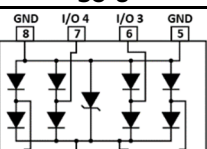
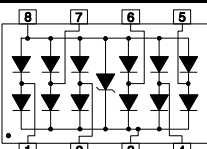
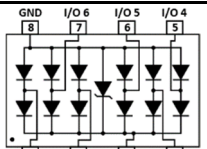
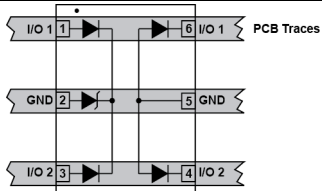
STEERING DIODE/TVS COMBO									
PART NUMBER	STAND-OFF VOLTAGE - V_{WM}	MIN. BREAKDOWN VOLTAGE - V_{BR}	CLAMPING VOLTAGE - $V_c @ I_{PP}$	CURRENT I_{PP} @ 8/20 μ s - A	LEAKAGE CURRENT - μ A @ V_{WM}	CAPACITANCE $C_{I(SD)}$ - pF	NUMBER OF LINES	POWER @ 8/20 μ s - WATTS	PIN CONFIGURATION
PSR05	5.0	6.0	20.0	28.0	5	10	2	500	 <p>SOT-143</p>
PSR05LC	5.0	6.0	20.0	28.0	5	2.5	2	500	 <p>SOT-143</p>
PSR3.3	3.3	-	15.0	10.0	1	0.6	2	150	 <p>SOT-143</p>
PSRDA3.3-4	3.3	4.0	6.5	1.0	125	5	4	500	 <p>SO-8</p>
PSRDA05-4	5.0	6.0	9.8	1.0	20	5	4	500	
PSRDA12-4	12.0	13.3	19.0	1.0	1	5	4	500	
PSRDA15-4	15.0	16.7	24.0	1.0	1	5	4	500	
PSRDA2.5-4A	2.5	3.0	5.5	1.0	0.5	5	4	500	 <p>SO-8</p>
PSRDA3.3-4A	3.3	4.0	6.5	1.0	0.5	5	4	500	
PSRDA3.3-6	3.3	4.0	6.5	1.0	125	5	6	500	 <p>SO-8</p>
PSRDA05-6	5.0	6.0	9.8	1.0	20	5	6	500	
PSRDA2.5-6A	2.5	3.6	5.5	1.0	0.5	5	6	500	 <p>SO-8</p>
PSRDA3.3-6A	3.3	4.0	6.5	1.0	0.5	5	6	500	
PSRV2.8-2LC	2.8	-	8.5	5.0	0.1	1	2	300	 <p>DFN-6</p>
PSRV3.3-2LC	3.3	3.5	15.0	10.0	0.1	1	2	300	
PSRV05-2LC	5.0	6.0	20.0	17.0	0.5	1	2	300	

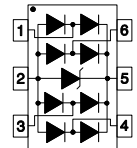
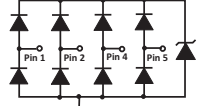
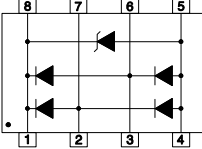
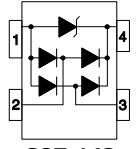
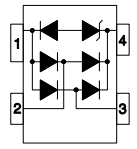
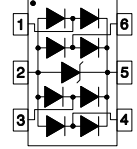
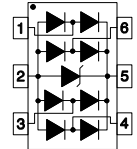
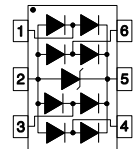
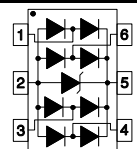
STEERING DIODE/TVS COMBO									
PART NUMBER	STAND-OFF VOLTAGE - V_{WM}	MIN. BREAKDOWN VOLTAGE - V_{BR}	CLAMPING VOLTAGE - $V_c @ I_{PP}$	CURRENT I_{PP} @ 8/20 μ s - A	LEAKAGE CURRENT - μ A @ V_{WM}	CAPACITANCE $C_{(SD)}$ - pF	NUMBER OF LINES	POWER @ 8/20 μ s - WATTS	PIN CONFIGURATION
PUSB05UBK	5.0	6.0	15.0	5.0	5	3.5	4	500	 <p>SOT-23-6</p>
PUSB403	3.3	4.5	7.4	5.0	0.1	0.6	4	-	 <p>DFN-10</p>
PUSB6B	5.25	6.0	13.2	35.0	10	15	2	500	 <p>SO-8</p>
SR12	12.0	13.3	30.0	16.0	1	10	2	500	 <p>SOT-143</p>
SR2.8	2.8	3.0 @ 2 μ A	8.5	5.0	1	4.5	2	300	 <p>SOT-143</p>
SR3.3	3.3	3.3 @ 2 μ A	15.0	10.0	1	4.5	2	300	
SRV05-4	5.0	6.0	15.0	5.0	5	3.5	4	500	 <p>SOT-23-6</p>
SRV05-4-A	5.0	6.0	21.0	12.0	1	3.0	4	250	 <p>SOT-23-6</p>
SRV05-4LC	5.0	6.0	15.0	5.0	5	0.7	4	500	 <p>SOT-23-6</p>
SRV05-4M	5.0	6.0	14.0	5.0	5	4.5	4	400	 <p>SOT-23-6</p>

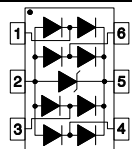
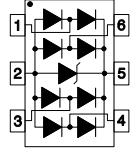
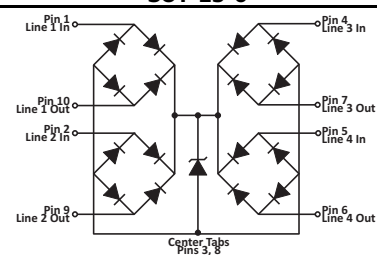
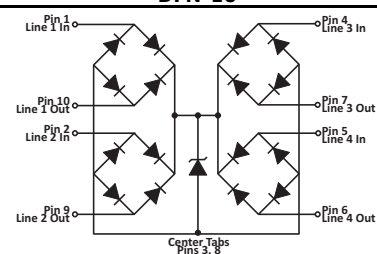
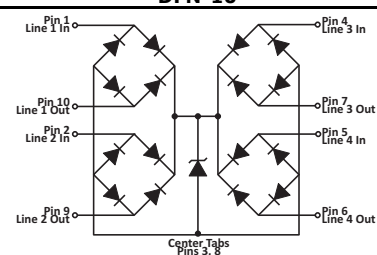
STEERING DIODE/TVS COMBO									
PART NUMBER	STAND-OFF VOLTAGE - V_{WM}	MIN. BREAKDOWN VOLTAGE - V_{BR}	CLAMPING VOLTAGE - $V_c @ I_{PP}$	CURRENT I_{PP} @ 8/20 μ s - A	LEAKAGE CURRENT - μ A @ V_{WM}	CAPACITANCE $C_{J(SD)}$ - pF	NUMBER OF LINES	POWER @ 8/20 μ s - WATTS	PIN CONFIGURATION
SRV05-4MT	5.0	6.0	14.0	5.0	5	4.5	4	400	 <p>SOT-23-6</p>
SRV2.8-4	2.8	3.0	8.5	5.0	5	3.5	4	600	 <p>SOT-23-6</p>
SRV25-4	2.5	3.0	7.4	10.0	0.5	3.5	4	800	 <p>DFN-10</p>
SRV25-4LC	2.5	3.0	7.4	10.0	0.1	1.0	4	400	 <p>DFN-10</p>
SRV3.3-4	3.3	3.9	12.5	15.0	0.5	3.5	4	800	 <p>DFN-10</p>

FLIP CHIP ARRAYS

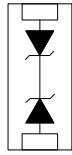
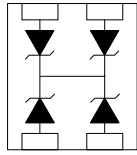
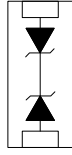

PART NUMBER	STAND-OFF VOLTAGE - V_{WM}	MIN. BREAKDOWN VOLTAGE - V_{BR}	CLAMPING VOLTAGE - $V_C @ I_{PP}$	CURRENT I_{PP} @ 8/20 μ s - A	LEAKAGE CURRENT - μ A @ V_{WM}	CAPACITANCE C_T - pF	NUMBER OF LINES	POWER @ 8/20 μ s - WATTS	PIN CONFIGURATION
P0402FC3.3C	3.3	4.0	12.5	20.0	75	150	1	250	 <p>0402</p>
P0402FC05C	5.0	6.0	14.7	17.0	10	100	1	250	
P0402FC08C	8.0	8.5	19.2	13.0	10	75	1	250	
P0402FC12C	12.0	13.3	29.7	9.0	1	50	1	250	
P0402FC15C	15.0	16.7	35.7	7.0	1	40	1	250	
P0402FC24C	24.0	26.7	55.0	5.0	1	30	1	250	
P0402FC36C	36.0	40.0	84.0	3.0	1	25	1	250	
P0404FC3.3C	3.3	4.0	12.5	20.0	75	150	1-3	250	 <p>0404</p>
P0404FC05C	5.0	6.0	14.7	17.0	10	100	1-3	250	
P0404FC08C	8.0	8.5	19.2	13.0	10	75	1-3	250	
P0404FC12C	12.0	13.3	29.7	9.0	1	50	1-3	250	
P0404FC15C	15.0	16.7	35.7	7.0	1	40	1-3	250	
P0404FC24C	24.0	26.7	55.0	5.0	1	30	1-3	250	
P0404FC36C	36.0	40.0	70.0	3.0	1	25	1-3	250	
Note: P040xFC Series are patented under U.S. Patent No. Des. D456,367S. Maximum Leakage current < 5 μ A @ 2.8V for P040xFC3.3C, <500nA @ 3.3V for P040xFC05C and < 200nA @ 5V for P040xFC08C.									
U0402FC3.3C	3.3	4.0	12.5	20.0	75	150	1	250	 <p>U0402</p>
U0402FC05C	5.0	6.0	14.7	17.0	10	100	1	250	
U0402FC08C	8.0	8.5	19.2	13.0	10	75	1	250	
U0402FC12C	12.0	13.3	29.7	9.0	1	50	1	250	
U0402FC15C	15.0	16.7	35.7	7.0	1	40	1	250	
U0402FC24C	24.0	26.7	55.0	5.0	1	30	1	250	
U0402FC36C	36.0	40.0	84.0	3.0	1	25	1	250	
Note: Maximum Leakage current < 5 μ A @ 2.8V for U0404FC3.3C, <500nA @ 3.3V for U0402FC05C and < 200nA @ 5V for U0402FC08C.									

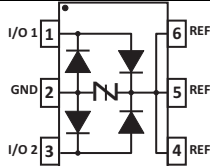
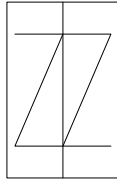
TVS/THYRISTOR COMBO

PART NUMBER	MIN. STAND-OFF VOLTAGE - V_{DRM}	MAX. SWITCHING VOLTAGE - V_S	TYP. HOLDING CURRENT - I_H	MIN. SWITCHING CURRENT - I_S	MAX. LEAKAGE CURRENT - μ A @ V_{DRM}	TYP. CAPACITANCE C_j - pF	NUMBER OF LINES	PIN CONFIGURATION
DSL03-24T	19	29	40	10	0.01	3.0	2	 <p>SOT-23-6</p>
PSMP30-240	240	-	150	-	2	10	1	 <p>DO-214AC</p>

STEERING DIODES							
PART NUMBER	REPETITIVE PEAK REV. VOLT. - V_{RRM}	FORWARD PEAK PULSE CURRENT - A	FORWARD VOLTAGE V_f @ I_f	LEAKAGE CURRENT - μA @ V_{RRM}	CAPACITANCE C_j - pF	NUMBER OF LINES	PIN CONFIGURATION
DALC112S1	20.0	12.0	1.3 @ 50mA	0.02 @ 18V	5	6	<p>SO-8</p>
DSL70	50.0	27.0	1.5 @ 1A	0.005	5	2	<p>SOT-143</p>
ET108	25.0	12.0	9 @ 12A	2	6	4	<p>SO-8</p>
ET720	30.0	12.0	2 @ 1A	0.02 @ 20V	3	14	<p>SO-16</p>
ET721	50.0	12.0	2 @ 1A	0.02	3	6	<p>SO-8</p>
ET723	20.0	12.0	2 @ 1A	0.02	5	6	<p>SO-8</p>
ET724	20.0	12.0	2 @ 1A	0.01	3	4	<p>SOT-23-6</p>
IO6LC	30.0	3.5	0.95 @ 20mA	0.1 @ 5.5V	3	6	<p>SO-8</p>

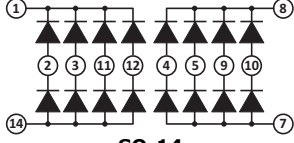
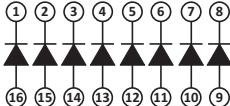
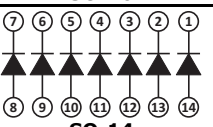
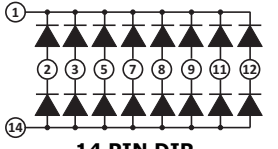
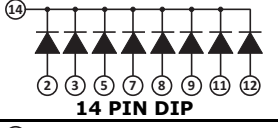
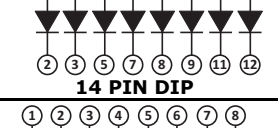
STEERING DIODES							
PART NUMBER	REPETITIVE PEAK REV. VOLT. - V_{RRM}	FORWARD PEAK PULSE CURRENT - A	FORWARD VOLTAGE $V_f @ I_f$	LEAKAGE CURRENT - μA @ V_{RRM}	CAPACITANCE C_j - pF	NUMBER OF LINES	PIN CONFIGURATION
MAD1103	50.0	12.0	1.2 @ 100mA	0.1 @ 40V	5	8	<p>14 PIN DIP</p>
MAD1105	50.0	12.0	1.2 @ 100mA	0.1 @ 40V	5	8	<p>14 PIN DIP</p>
MAD1106	50.0	12.0	1.2 @ 100mA	0.1 @ 40V	5	8	<p>14 PIN DIP</p>
MAD1107	50.0	12.0	1.2 @ 100mA	0.1 @ 40V	5	8	<p>14 PIN DIP</p>
MAD1108	50.0	12.0	1.2 @ 100mA	0.1 @ 40V	5	8	<p>16 PIN DIP</p>
MAD1109	50.0	12.0	1.2 @ 100mA	0.1 @ 40V	5	7	<p>14 PIN DIP</p>
MMAD130	50.0	12.0	1.2 @ 100mA	0.1 @ 40V	5	8	<p>SO-14</p>
MMAD1103	50.0	12.0	1.2 @ 100mA	0.1 @ 40V	5	8	<p>SO-14</p>
MMAD1105	50.0	12.0	1.2 @ 100mA	0.1 @ 40V	5	8	<p>SO-14</p>
MMAD1106	50.0	12.0	1.2 @ 100mA	0.1 @ 40V	5	8	<p>SO-14</p>

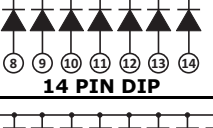
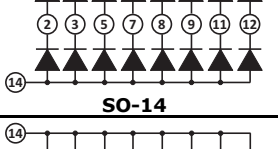
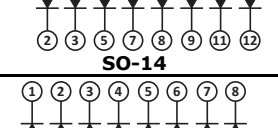
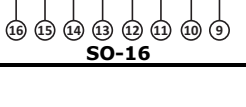
STEERING DIODES							
PART NUMBER	REPETITIVE PEAK REV. VOLT. - V_{RRM}	FORWARD PEAK PULSE CURRENT - A	FORWARD VOLTAGE $V_f @ I_f$	LEAKAGE CURRENT - μA @ V_{RRM}	CAPACITANCE C_j - pF	NUMBER OF LINES	PIN CONFIGURATION
MMAD1107	50.0	12.0	1.2 @ 100mA	0.1 @ 40V	5	8	 <p>SO-14</p>
MMAD1108	50.0	12.0	1.2 @ 100mA	0.1 @ 40V	5	8	 <p>SO-16</p>
MMAD1109	50.0	12.0	1.2 @ 100mA	0.1 @ 40V	5	8	 <p>SO-14</p>
PMAD1103	50.0	40.0	1.2 @ 100mA	0.1 @ 40V	5	8	 <p>14 PIN DIP</p>
PMAD1105	50.0	40.0	1.2 @ 100mA	0.1 @ 40V	5	8	 <p>14 PIN DIP</p>
PMAD1106	50.0	40.0	1.2 @ 100mA	0.1 @ 40V	5	8	 <p>14 PIN DIP</p>
PMAD1108	50.0	40.0	1.2 @ 100mA	0.1 @ 40V	5	8	 <p>16 PIN DIP</p>
PMAD1109	50.0	40.0	1.2 @ 100mA	0.1 @ 40V	5	7	 <p>14 PIN DIP</p>
PMMAD1103	50.0	40.0	1.2 @ 100mA	0.1 @ 40V	5	8	 <p>SO-14</p>
PMMAD1106	50.0	40.0	1.2 @ 100mA	0.1 @ 40V	5	8	 <p>SO-14</p>
PMMAD1108	50.0	40.0	1.2 @ 100mA	0.1 @ 40V	5	8	 <p>SO-16</p>

STEERING DIODES							
PART NUMBER	REPETITIVE PEAK REV. VOLT. - V_{RRM}	FORWARD PEAK PULSE CURRENT - A	FORWARD VOLTAGE V_F @ I_F	LEAKAGE CURRENT - μA @ V_{RRM}	CAPACITANCE C_j - pF	NUMBER OF LINES	PIN CONFIGURATION
PMMAD1109	50.0	40.0	1.2 @ 100mA	0.1 @ 40V	5	7	<p>SO-14</p>
PSRDA70-4	70.0	24.0	1.1 @ 100mA	5	6	4	<p>SO-8</p>
SR70	70.0	30.0	1.5 @ 1A	1	5	2	<p>SOT-143</p>
USB002	20.0	12.0	1.4 @ 10mA	1 @ 5V	0.6	2	<p>SOT-543</p>
USB004	20.0	12.0	0.95 @ 20mA	1 @ 5V	6.0	2	<p>SOT-143</p>
USB208	20.0	12.0	1.2 @ 50mA	1 @ 5V	5	4	<p>SOT-23-6</p>

EMI FILTER/TVS DIODE ARRAYS								
PART NUMBER	STAND-OFF VOLTAGE - V_{WM}	MIN. BREAKDOWN VOLTAGE - V_{BR} @ 1 mA	REVERSE LEAKAGE CURRENT - μA @ V_{WM}	RESISTANCE $\pm 20\%$ - OHMS	CUT-OFF FREQUENCY - MHZ (50 Ohm System)	CAPACITANCE C_T - pF	NUMBER OF LINES	PIN CONFIGURATION
EM02-100	5.0	6.0	0.1	100	110	30	2	<p>SOT-563</p>
EM1631-08DSL	5.0	6.0	0.1	100	110	30	8	<p>DFN-16SLP</p> <p>I/O connected from pins 1-16, 2-15, 3-14, 4-13, 5-12, 6-11, 7-10 and 8-9.</p>
EM4D-100L	5.0	6.0	0.1 @ 3V	100	150	20	4	<p>DFN-8/LP</p>
EM4DLP-100L	5.0	6.0	0.1 @ 3V	100	150	20	4	
EM8D-100L	5.0	6.0	0.1 @ 3V	100	150	20	8	<p>DFN-16/LP/SLP</p>
EM8DLP-100L	5.0	6.0	0.1 @ 3V	100	150	20	8	
EM8DSPL-100L	5.0	6.0	0.1 @ 3V	100	150	20	8	
EM8Q-100	5.0	6.0	0.1 @ 3V	100	150	20	8	<p>QFN-16</p> <p>Center tab as the ground</p>
PAM24DF1605	5.0	6.0	0.1 @ 3V	100	110	30	8	<p>DFN-16</p> <p>I/O connected from pins 1-16, 2-15, 3-14, 4-13, 5-12, 6-11, 7-10 and 8-9.</p>
STF701	5.0	6.0	1.0 @ 3.3V	-	-	160	2	<p>SC70-5L</p>

THYRISTORS									PIN CONFIGURATION
PART NUMBER	REPETITIVE PEAK OFF-STATE VOLTAGE - V_{DRM}	SWITCHING VOLTAGE - V_s	MINIMUM HOLDING CURRENT - I_H mA	SWITCHING CURRENT - I_S mA	MAX. OFF-STATE CURRENT - μA @ V_{DRM}	MAX. ON-STATE VOLTAGE - V_T	ON-STATE CURRENT - I_T A	CAPACITANCE C_T - pF	
PP0080SA	6	25	50	800	5	4	2.2	50	
PP0300SA	25	40	50	800	5	4	2.2	60	
PP0640SA	58	77	150	800	5	4	2.2	60	
PP0720SA	65	88	150	800	5	4	2.2	60	
PP0800SA	75	98	150	800	5	4	2.2	60	
PP1100SA	90	130	150	800	5	4	2.2	60	
PP1300SA	120	160	150	800	5	4	2.2	40	
PP1500SA	140	180	150	800	5	4	2.2	40	
PP1800SA	160	220	150	800	5	4	2.2	40	
PP2300SA	190	260	150	800	5	4	2.2	30	
PP2600SA	220	300	150	800	5	4	2.2	30	
PP3100SA	275	350	150	800	5	4	2.2	30	
PP3500SA	300	400	150	800	5	4	2.2	30	
PP0080SB	6	25	50	800	5	4	2.2	60	
PP0300SB	25	40	50	800	5	4	2.2	110	
PP0640SB	58	77	150	800	5	4	2.2	60	
PP0720SB	65	88	150	800	5	4	2.2	60	
PP0800SB	75	98	150	800	5	4	2.2	60	
PP1100SB	90	130	150	800	5	4	2.2	60	
PP1300SB	120	160	150	800	5	4	2.2	40	
PP1500SB	140	180	150	800	5	4	2.2	40	
PP1800SB	160	220	150	800	5	4	2.2	40	
PP2300SB	190	260	150	800	5	4	2.2	30	
PP2600SB	220	300	150	800	5	4	2.2	30	
PP3100SB	275	350	150	800	5	4	2.2	30	
PP3500SB	300	400	150	800	5	4	2.2	30	
PP0080SC	6	25	50	800	5	4	2.2	30	
PP0300SC	25	40	50	800	5	4	2.2	60	
PP0640SC	58	77	150	800	5	4	2.2	120	
PP0720SC	65	88	150	800	5	4	2.2	120	
PP0800SC	75	98	150	800	5	4	2.2	120	
PP1100SC	90	130	150	800	5	4	2.2	120	
PP1300SC	120	160	150	800	5	4	2.2	80	
PP1500SC	140	180	150	800	5	4	2.2	80	
PP1800SC	160	220	150	800	5	4	2.2	80	
PP2300SC	190	260	150	800	5	4	2.2	60	
PP2600SC	220	300	150	800	5	4	2.2	60	
PP3100SC	275	350	150	800	5	4	2.2	60	
PP3500SC	300	400	150	800	5	4	2.2	60	

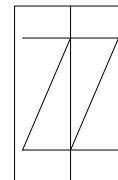





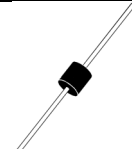
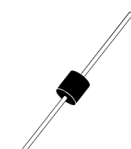
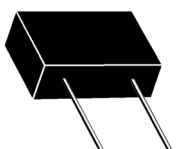
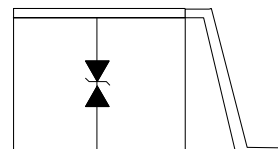
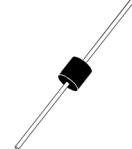
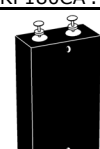

DO-214AA

SURGE RATINGS								
SERIES	I_{PP} 2 X 10 μ s AMPS	I_{PP} 8 X 20 μ s AMPS	I_{PP} 10 X 160 μ s AMPS	I_{PP} 10 X 560 μ s AMPS	I_{PP} 10 X 1000 μ s AMPS	I_{RSM} 60 Hz AMPS	di/dt AMPS/ μ s (Note 1)	dv/dt V/ μ s (Note 1)
SA	150	150	100	50	50	20	500	2000
SB	300	300	150	100	80	32	500	2000
SC	500	400	200	200	100	60	500	2000

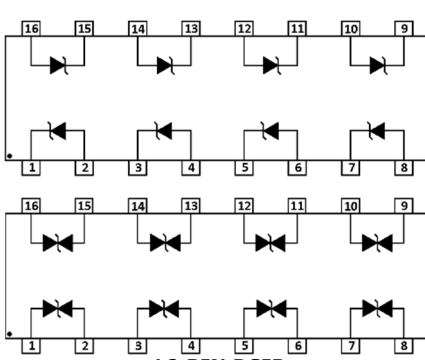
Note 1: Critical Rate of Rise for On-State Current (di/dt) and Off-State Voltage (dv/dt).

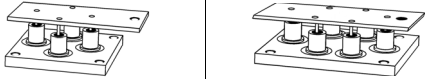
MODULES – COMPONENTS (NOT ROHS COMPLIANT)

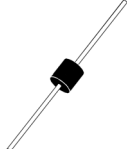
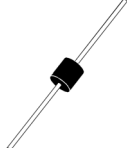
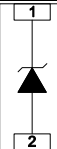
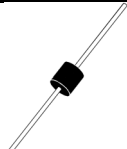
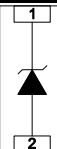
PART NUMBER	STAND-OFF VOLTAGE - V_{WM}	MIN. BREAKDOWN VOLTAGE - V_{BR}	CLAMPING VOLTAGE - V_c	CURRENT I_{PP} @ 10/1000 μ s - A	LEAKAGE CURRENT - μ A @ V_{WM}	POWER @ 10/1000 μ s - kW	PACKAGE
1.5KE6.8	5.5	6.12	10.8	139.0	1000	1.5	 AXIAL LEAD
Not all voltages show for the 1.5KE Series. Please consult the factory for other voltages.							
1.5KE600A	513.0	570.0	828.0	1.8	1	1.5	
Note: Part numbers shown are unidirectional devices. Add a "CA" suffix to specify bidirectional devices, such as '1.5KE520CA'.							
15KP17	17.0	18.9	32.3	464.0	5000	15	 AXIAL LEAD (KPA Series)  THRU-HOLE (KP Series)
Not all voltages show for the 15KP Series. Please consult the factory for other voltages.							
15KP280A	280.0	311.0	452.0	33.0	10	15	
15KPA17	17.0	18.9	32.3	464.0	5000	15	
Not all voltages show for the 15KPA Series. Please consult the factory for other voltages.							
15KPA280A	280.0	311.0	452.0	33.0	10	15	
30KPA28A	28.0	31.3	50.0	606.0	5000	30	
Not all voltages show for the 30KPA Series. Please consult the factory for other voltages.							
30KPA360A	360.0	400.0	640.0	55.0	2	30	
Note: Part numbers shown are unidirectional devices. Add a "CA" suffix to specify bidirectional devices, such as '15KP17CA'.							
2700SM28CAN	28.0	31.0	45.5	15K	800	2250	
2700SM78CAN	78.0	86.0	150.0	15K	10	2250	
5KP5.0A	5.0	6.4	9.2	543	5000	5	 AXIAL LEAD
Not all voltages show for the 5KP Series. Please consult the factory for other voltages.							
5KP440A	440.0	492.0	713.0	7.0	2	5	
Note: Part numbers shown are unidirectional devices. Add a "CA" suffix to specify bidirectional devices, such as '5KP180CA'.							
60KS200C	180.0	200.0	335.0	180.0	10	60kW @ 1.2/50 μ s	
90KS200C	180.0 180.0	200.0 200.0	280.0 335.0	180.0 270.0	0.5 0.5	90kW @ 1.2/50 μ s	
704-15K36	31.5	36.0	53.0	300.0	100	15	 
704-15K36P	31.5	36.0	53.0	300.0	100	15	
704-15K36T	31.5	36.0	53.0	300.0	500	15	
DD3K06CA	6.0	6.67	10.3	291.3	1000	3000	 16-PIN DSIP
DD3K09CA	9.0	10.0	15.4	194.8	10	3000	
DD3K12CA	12.0	13.3	19.9	150.6	5	3000	
DD3K18CA	18.0	20.0	29.2	102.8	2	3000	
DD3K30A	30.0	33.3	48.4	62.0	2	3000	
DD3K40A	40.0	44.4	64.5	46.4	2	3000	

MODULES – COMPONENTS (NOT ROHS COMPLIANT)							
PART NUMBER	STAND-OFF VOLTAGE - V_{WM}	MIN. BREAKDOWN VOLTAGE - V_{BR}	CLAMPING VOLTAGE - V_c	CURRENT I_{PP} @ 10/1000 μ s - A	LEAKAGE CURRENT - μ A @ V_{WM}	POWER @ 10/1000 μ s - kW	PACKAGE
GPZ532	28.0	32.0	40.0	100	50	10kW @ 1ms	
GPZ1275	28.0	32.0	55.0	500	60	30kW @ 1ms	
GPZ1275B60K	28.0	32.0	55.0	1000	60	60kW @ 1ms	
Note: I_{PP} @ 1 ms for GPZ Series.							
K1-076	54.0	83.0	135.0	-	20	-	 AXIAL LEAD
Not all voltages show for the K Series. Please consult the factory for other voltages.							
KD-076	54.0	85.0	145.0	-	20	-	
Note: K1, KA, KB, Kc and KD Series is available. Please consult factory for more information.							
P15KP17	17.0	18.9	32.3	464.0	5000	15	 AXIAL LEAD
Not all voltages show for the P15KP Series. Please consult the factory for other voltages.							
P15KP280A	280.0	311.0	452.0	33.0	10	15	
P30KP30A	30.0	33.3	55.2	543.0	5000	30	
Not all voltages show for the P30KP Series. Please consult the factory for other voltages.							
P30KP260A	260.0	289.0	416.0	72.0	10	30	
Note: Part numbers shown are unidirectional devices. Add a "CA" suffix to specify bidirectional devices, such as 'P15KP17CA'.							
P6KE6.8	5.5	6.12	10.8	55.6	1000	600	 AXIAL LEAD
Not all voltages show for the P6KE Series. Please consult the factory for other voltages.							
P6KE600A	513.0	570.0	828.0	0.7	1	600	
Note: Part numbers shown are unidirectional devices. Add a "CA" suffix to specify bidirectional devices, such as 'P6KE520CA'.							
PAM07DF23K24	24	26.7	43.0	69.8	3	3	 DFN-2-3KW
Note: ROHS Compliant.							
PAM16AL30A	30.0	33.3	50.7	296.0	15	15	 AXIAL LEAD
PAM25DF25K33	33.0	36.8	53.3	94.0	8	5	 DFN-2-5KW
PAM25DF25K36	36.0	40.2	58.1	86.0	8	5	
Note: ROHS Compliant.							
PDTV58CA	58.0	64.0	110	3kA	10	-	 2-LEAD ENCAPSULATED COMPONENT
PDTV576CA	76.0	85.0	140	3kA	10	-	

MODULES – COMPONENTS (NOT ROHS COMPLIANT)

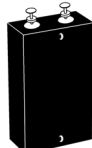
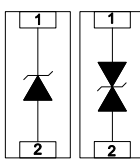
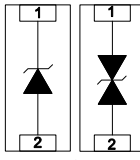
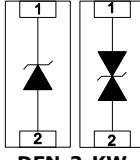
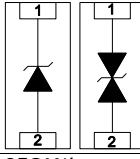
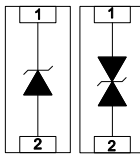
PART NUMBER	STAND-OFF VOLTAGE - V_{WM}	MIN. BREAKDOWN VOLTAGE - V_{BR}	CLAMPING VOLTAGE - V_C	CURRENT I_{PP} @ 10/1000 μ s - A	LEAKAGE CURRENT - μ A @ V_{WM}	POWER @ 10/1000 μ s - kW	PACKAGE
PHP8.4	12.0	14.0	22.0	341.0	250	7.5	
PHP24	34.0	40.0	67.0	112.0	250	7.5	
PHP30	42.5	50.0	84.0	90.0	250	7.5	
PHP60	85.0	100.0	167.0	90.0	250	15	
PHP120*	170.0	200.0	319.0	47.0	250	15	
PHP208	295.0	347.0	536.0	28.0	250	15	
PHP250*	354.0	418.0	652.0	23.0	250	15	
PHP275	390.0	460.0	710.0	21.0	250	15	
PHP440	623.0	735.0	1138.0	13.2	250	15	
PHP500*	708.0	835.0	1292.0	11.6	250	15	
PIP8.4	12.0	14.0	22.0	341.0	250	7.5	
PIP24	34.0	40.0	67.0	112.0	250	7.5	
PIP30	42.5	50.0	84.0	90.0	250	7.5	
PIP60	85.0	100.0	167.0	90.0	250	15	
PIP120*	170.0	200.0	319.0	47.0	250	15	
PIP208	295.0	347.0	536.0	28.0	250	15	
PIP250*	354.0	418.0	652.0	23.0	250	15	
PIP440	623.0	735.0	1138.0	13.2	250	15	
PIP500*	708.0	835.0	1292.0	11.6	250	15	
Note: PHP Series is typically used in Aerospace applications. PIP Series is typically used in Industrial applications. *indicates marine applications.							
SM10KW10A	10.0	11.1	20.0	3000	15	8.5	 <p>DFN-2-KW</p>
SM10KW12A	12.0	13.4	24.0	2500	8	8.5	
SM10KW15A	15.0	16.5	30.0	2000	8	8.5	
SM10KW22A	22.0	24.4	40.2	1492	8	8.5	
SM10KW24A	24.0	26.8	48.3	1242	8	8.5	
SM10KW28A	28.0	31.2	56.1	1069	8	8.5	
SM10KW30A	30.0	33.5	60.3	995	8	8.5	
SM10KW33A	33.0	36.8	66.0	909	8	8.5	
SM10KW36A	36.0	40.0	72.3	829	8	8.5	
Note: Part numbers shown are unidirectional. Add a "C" suffix to specify bidirectional devices, such as 'SM10KW36CA'. ROHS Compliant.							
SM10KWE10A	10.0	11.1	17.0	588	15	10	 <p>DFN-2-KW</p>
SM10KWE12A	12.0	13.4	19.9	502	8	10	
SM10KWE22A	22.0	24.4	36.5	282	8	10	
SM10KWE24A	24.0	26.8	38.9	258	8	10	
SM10KWE28A	28.0	31.2	45.4	220	8	10	
SM10KWE30A	30.0	33.5	48.4	206	8	10	
SM10KWE33A	33.0	36.8	53.3	187	8	10	
SM10KWE36A	36.0	40.0	58.1	172	8	10	
SM10KWE48A	48.0	53.0	77.4	129	8	10	
Note: Part numbers shown are unidirectional. Add a "C" suffix to specify bidirectional devices, such as 'SM10KWE36CA'. ROHS Compliant							
SM15KWE24A	24.0	26.7	38.9	384	15	15	 <p>DFN-2-KW</p>
SM15KWE30A	30.0	33.3	50.7	296	15	15	
SM15KWE36A	36.0	40.0	59.7	251	10	15	
SM15KWE48A	48.0	53.3	77.7	193	10	15	
SM15KWE70A	70.0	77.8	114.0	132.0	10	15	
Note: Part numbers shown are unidirectional. Add a "C" suffix to specify bidirectional devices, such as 'SM15KWE36CA'. ROHS Compliant							
SM15KPA17AN	17.0	18.9	29.3	512.0	5000	15	
Not all voltages show for the SM15KPaxxAN/CAN Series. Please consult the factory for other voltages.							
SM15KPA480AN	480.0	528.0	791.0	18.9	10	15	
Note: Part numbers shown are unidirectional. Add a "C" suffix to specify bidirectional devices, such as 'SM15KPA85CAN'.							
SM30KPA28AN	28.0	31.3	50.0	606.0	5000	30	
Not all voltages show for the SM30KPaxxAN/CAN Series. Please consult the factory for other voltages.							
SM30KPA480AN	480.0	528.0	791.0	37.8	2	30	
Note: Part numbers shown are unidirectional. Add a "C" suffix to specify bidirectional devices, such as 'SM30KPA28CAN'.							

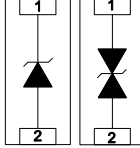
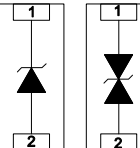
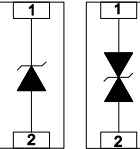
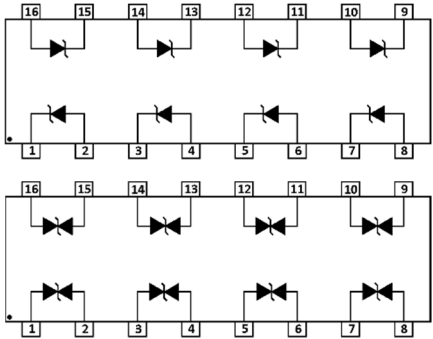
MODULES – COMPONENTS (NOT ROHS COMPLIANT)							
PART NUMBER	STAND-OFF VOLTAGE - V_{WM}	MIN. BREAKDOWN VOLTAGE - V_{BR}	CLAMPING VOLTAGE - V_c	CURRENT I_{pp} @ 10/1000 μ s - A	LEAKAGE CURRENT - μ A @ V_{WM}	POWER @ 10/1000 μ s - kW	PACKAGE
SM45KPA70AN	70.0	77.8	120.0	375.0	2	45	
Not all voltages show for the SM45KPaxxAN/CAN Series. Please consult the factory for other voltages.							
SM45KPA200AN	200.0	222.0	350.0	128.0	2	45	
Note: Part numbers shown are unidirectional. Add a "C" suffix to specify bidirectional devices, such as 'SM45KPA70CAN'.							
SM3KW08A	8	8.8	13.6	220	50	3	
SM3KW24A	24	26.7	43.0	69.8	3	3	
SM3KW33A	33	36.7	56.3	53.3	3	3	
Note: Part numbers shown are unidirectional. Add a "C" suffix to specify bidirectional devices, such as 'SM3KW33CA'. ROHS Compliant.							
SM5KW10A	10	11.1	17.0	296.0	15	5	
SM5KW33A	33.0	36.8	53.3	94.0	8	5	
SM5KW36A	36.0	40.2	58.1	86.0	8	5	
Note: Part numbers shown are unidirectional. Add a "C" suffix to specify bidirectional devices, such as 'SM5KW33CA'. ROHS Compliant.							
SMDD3K06CA	6.0	6.67	10.3	291.3	1000	3000	
SMDD3K09CA	9.0	10.0	15.4	194.8	10	3000	
SMDD3K12CA	12.0	13.3	19.9	150.6	5	3000	
SMDD3K18CA	18.0	20.0	29.2	102.8	2	3000	
SMDD3K30A	30.0	33.3	48.4	62.0	2	3000	
SMDD3K40A	40.0	44.4	64.5	46.4	2	3000	

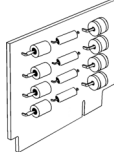
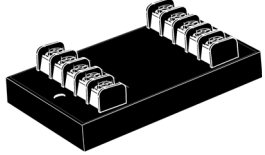
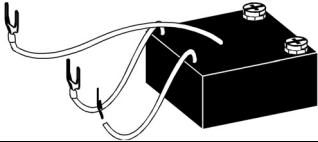
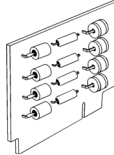
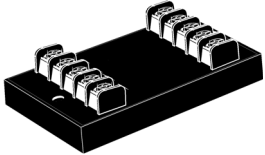
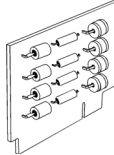
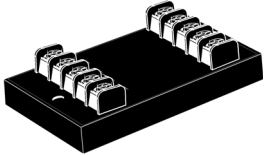
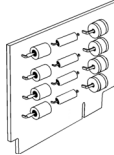
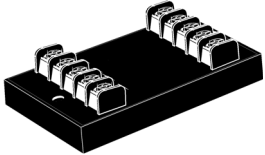
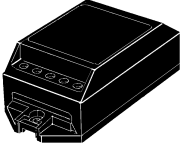
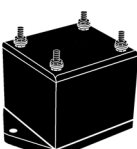
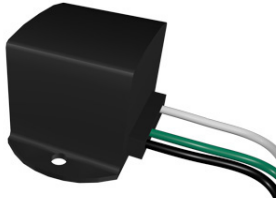
MODULES – SURGEBUSTERS™ (NOT ROHS COMPLIANT)										
PART NUMBER	STAND-OFF VOLTAGE - V_{WM}	CLAMPING VOLTAGE - V_c @ 8/20 μ S	MAX. CURRENT @ 8/20 μ s – kA/Line	LEAKAGE CURRENT - μ A @ V_{WM}	SERIES RESISTANCE OHMS	CAPACITANCE pF	PACKAGE			
232B	±25	40.0 @ 500A	10	5	12	2000				
232E	±25	40.0 @ 500A	10	5	12	2000				
Note: Lines of protection: 2 pair.										
420E212	±12.0	22.0 @ 2kA	10	5	12	6000				
420E225	±25.0	44.0 @ 2kA	10	5	12	3000				
420E228	±28.0	46.0 @ 2kA	10	5	12	2800				
420E236	±36.0	60.0 @ 2kA	10	5	12	1500				
420E250	±50.0	80.0 @ 2kA	10	5	12	1200				
420E260	±60.0	95.0 @ 2kA	10	5	12	1000				
Note: Lines of protection: 1 pair.										
420LB28	±28.0	40.0 @ 2kA	10	5	12	2800				
420LB35	±35.0	60.0 @ 2kA	10	5	12	1500				
420LB60	±60.0	85.0 @ 2kA	10	5	12	1000				
420LE28	±28.0	40.0 @ 2kA	10	5	12	2800				
420LE35	±35.0	60.0 @ 2kA	10	5	12	1500				
420LE60	±60.0	85.0 @ 2kA	10	5	12	1000				
Note: Lines of protection: 2 pair.										
422B	±12.0	24.0 @ 500A	10	5	12	5000				
422E	±12.0	24.0 @ 500A	10	5	12	5000				
Note: Lines of protection: 2 pair.										
422ELC	±12.0	30.0 @ 500A	10	1	12	25				
485ELC	±7.0	20.0 @ 500A	10	10	12	25				
Note: Lines of protection: 2 pair.										
587B051	130.0 AC	350.0	3	1mA	-	-				
587B151	130.0 AC	350.0	3	1mA	-	-				
587B201	130.0 AC	350.0	3	1mA	-	-				
587B301	130.0 AC	350.0	3	1mA	-	-				
Note: Maximum Line Current: 5A, 15A, 20A, 30. Line to Neutral.										
587B062	240.0 AC	800.0	3	1mA	-	-				
587B162	240.0 AC	800.0	3	1mA	-	-				
587B302	240.0 AC	800.0	3	1mA	-	-				
Note: Maximum Line Current: 6A, 16A, 30A. Line to Neutral.										
587B051LP	120.0 AC	330.0	3	1mA	-	-				
587B101LP	120.0 AC	330.0	3	1mA	-	-				
587B151LP	120.0 AC	330.0	3	1mA	-	-				
587B301LP	120.0 AC	330.0	3	1mA	-	-				
Note: Maximum Line Current: 5A, 10A, 15A, 30A. Line to Neutral.										
587B062LP	240.0 AC	800.0	3	1mA	-	-				
587B102LP	240.0 AC	800.0	3	1mA	-	-				
587B162LP	240.0 AC	800.0	3	1mA	-	-				
587B302LP	240.0 AC	800.0	3	1mA	-	-				
Note: Maximum Line Current: 6A, 10A, 16A, 30A. Line to Neutral.										
587B062LPE	240.0 AC	800.0	3	1mA	-	-				
587B102LPE	240.0 AC	800.0	3	1mA	-	-				
587B162LPE	240.0 AC	800.0	3	1mA	-	-				
587B302LPE	240.0 AC	800.0	3	1mA	-	-				
Note: Maximum Line Current: 6A, 10A, 16A, 30A. Line to Neutral.										
PBSP-120-10K	120	660	10	-	-	1500				
PBSP-220-10K	220	1350	10	-	-	750				
PBSP-240-10K	240	1355	10	-	-	740				
PBSP-277-10K	277	1400	10	-	-	720				
PBSP-380-10K	380	1680	10	-	-	600				
PBSP-120-20K	120	650	20	-	-	3000				
PBSP-220-20K	220	1350	20	-	-	1500				
PBSP-240-20K	240	1355	20	-	-	1480				
PBSP-277-20K	277	1500	20	-	-	1400				

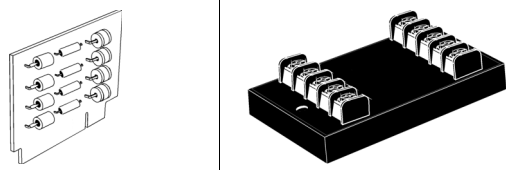
MODULES – SURGEBUSTERS™ (NOT ROHS COMPLIANT)							
PART NUMBER	STAND-OFF VOLTAGE - V_{WM}	CLAMPING VOLTAGE - V_c @ 8/20 μ S	MAX. CURRENT @ 8/20 μ s – kA/Line	LEAKAGE CURRENT - μ A @ V_{WM}	SERIES RESISTANCE OHMS	CAPACITANCE pF	PACKAGE 
TEL50B	±50.0	95.0 @ 500A	10	5	12	800	
TEL50E	±50.0	95.0 @ 500A	10	5	12	800	
TEL185B	±185.0	330.0 @ 500A	10	5	12	800	
TEL185E	±185.0	330.0 @ 500A	10	5	12	800	
Note: Lines of protection: 2 pair.							

OVERCURRENT PROTECTION: FUSES

PART NUMBER	CURRENT RATING Amps	VOLTAGE RATING Volts DC	INTERRUPTING RATING Amps DC	TYPICAL RESISTANCE Ohms	TYPICAL MELT I ² t DC(A ² s)	AMPERE RATING	%OF AMP RATING	PACKAGE
PF0402F200	0.200	24	35	4.300	0.0008	200mA-4A	100/250	0402
PF0402F250	0.250	24	35	3.20	0.0011	200mA-4A	100/250	0402
PF0402F375	0.350	24	35	1.140	0.0021	200mA-4A	100/250	0402
PF0402F500	0.500	24	35	1.20	0.0043	200mA-4A	100/250	0402
PF0402F750	0.750	24	35	0.520	0.0110	200mA-4A	100/250	0402
PF0402F1	1.00	24	35	0.090	0.049	200mA-4A	100/250	0402
PF0402F1.25	1.25	24	35	0.075	0.052	200mA-4A	100/250	0402
PF0402F1.5	1.50	24	35	0.058	0.076	200mA-4A	100/250	0402
PF0402F1.75	1.75	24	35	0.045	0.13	200mA-4A	100/250	0402
PF0402F2	2.00	24	35	0.035	0.18	200mA-4A	100/250	0402
PF0402F2.5	2.50	24	35	0.025	0.23	200mA-4A	100/250	0402
PF0402F3	3.00	24	35	0.019	0.33	200mA-4A	100/250	0402
PF0402F3.5	3.50	24	35	0.018	0.45	200mA-4A	100/250	0402
PF0402F4	4.00	24	35	0.014	0.65	200mA-4A	100/250	0402
Note: Opening Time – 4 Hours Minimum, 5 seconds Maximum.								
PF0603F250	0.250	32	50	5.1	0.0004	250mA-6A	100/250	0603
PF0603F375	0.375	32	50	2.4	0.0009	250mA-6A	100/250	0603
PF0603F500	0.500	32	50	1.1	0.0018	250mA-6A	100/250	0603
PF0603F750	0.750	32	50	0.7	0.0070	250mA-6A	100/250	0603
PF0603F1	1.00	32	50	0.23	0.015	250mA-6A	100/250	0603
PF0603F1.25	1.25	32	50	0.165	0.022	250mA-6A	100/250	0603
PF0603F1.5	1.50	32	50	0.125	0.032	250mA-6A	100/250	0603
PF0603F1.75	1.75	32	50	0.08	0.048	250mA-6A	100/250	0603
PF0603F2	2.00	32	50	0.063	0.052	250mA-6A	100/250	0603
PF0603F2.5	2.50	32	50	0.04	0.061	250mA-6A	100/250	0603
PF0603F3	3.00	32	50	0.028	0.070	250mA-6A	100/250	0603
PF0603F3.5	3.50	32	50	0.022	0.122	250mA-6A	100/250	0603
PF0603F4	4.00	32	50	0.018	0.220	250mA-6A	100/250	0603
PF0603F5	5.00	32	50	0.011	0.680	250mA-6A	100/250	0603
PF0603F6	6.00	32	50	0.008	0.920	250mA-6A	100/250	0603
Note: Opening Time – 4 Hours Minimum, 5 seconds Maximum.								
PF0603H1	1.00	32	35	0.24	0.09	1A-5A	100/200/1000	0603
PF0603H1.5	1.50	32	35	0.12	0.18	1A-5A	100/200/1000	0603
PF0603H2	2.00	32	35	0.068	0.29	1A-5A	100/200/1000	0603
PF0603H2.5	2.50	32	35	0.048	0.59	1A-5A	100/200/1000	0603
PF0603H3	3.00	32	35	0.034	0.83	1A-5A	100/200/1000	0603
PF0603H3.5	3.50	32	35	0.023	1.23	1A-5A	100/200/1000	0603
PF0603H4	4.00	32	35	0.02	2.22	1A-5A	100/200/1000	0603
PF0603H4.5	4.5	32	35	0.016	2.70	1A-5A	100/200/1000	0603
PF0603H5	5.00	32	35	0.013	3.20	1A-5A	100/200/1000	0603
Note: Opening Time – 4 Hours Minimum, 1~60 seconds, 0.0002~0.02 seconds.								

OVERCURRENT PROTECTION: FUSES

PART NUMBER	CURRENT RATING Amps	VOLTAGE RATING Volts DC	INTERRUPTING RATING Amps DC	TYPICAL RESISTANCE Ohms	TYPICAL MELT I ² t DC(A ² s)	AMPERE RATING	%OF AMP RATING	PACKAGE
PF0603S1	1.00	32	35	0.25	0.09	1A-5A	100/200/300/800	0603
PF0603S1.5	1.50	32	35	0.13	0.19	1A-5A	100/200/300/800	0603
PF0603S2	2.00	32	35	0.07	0.30	1A-5A	100/200/300/800	0603
PF0603S2.5	2.50	32	35	0.05	0.61	1A-5A	100/200/300/800	0603
PF0603S3	3.00	32	35	0.035	0.83	1A-5A	100/200/300/800	0603
PF0603S3.5	3.50	32	35	0.024	1.23	1A-5A	100/200/300/800	0603
PF0603S4	4.00	32	35	0.02	2.22	1A-5A	100/200/300/800	0603
PF0603S4.5	4.50	32	35	0.016	2.74	1A-5A	100/200/300/800	0603
PF0603S5	5.00	32	35	0.013	3.40	1A-5A	100/200/300/800	0603
Note: Opening Time – 4 Hours Minimum, 1~120 seconds, 0.1~3 seconds, 0.001~0.05 seconds. Ceramic and glass package.								
PF1206F250	0.250	63	50	4.10	0.0004	250mA-8A	100/250	1206
PF1206F375	0.375	63	50	2.21	0.0008	250mA-8A	100/250	1206
PF1206F500	0.500	63	50	1.50	0.0018	250mA-8A	100/250	1206
PF1206F750	0.750	63	50	0.60	0.0055	250mA-8A	100/250	1206
PF1206F1	1.00	63	50	0.26	0.030	250mA-8A	100/250	1206
PF1206F1.25	1.25	63	50	0.24	0.046	250mA-8A	100/250	1206
PF1206F1.5	1.50	63	50	0.12	0.083	250mA-8A	100/250	1206
PF1206F1.75	1.75	63	50	0.10	0.090	250mA-8A	100/250	1206
PF1206F2	2.00	63	50	0.072	0.110	250mA-8A	100/250	1206
PF1206F2.5	2.50	63	50	0.051	0.240	250mA-8A	100/250	1206
PF1206F3	3.00	63	50	0.038	0.255	250mA-8A	100/250	1206
PF1206F3.5	3.50	32	50	0.025	0.280	250mA-8A	100/250	1206
PF1206F4	4.00	32	50	0.020	0.305	250mA-8A	100/250	1206
PF1206F4.5	4.50	32	50	0.017	0.395	250mA-8A	100/250	1206
PF1206F5	5.00	32	50	0.016	0.500	250mA-8A	100/250	1206
PF1206F6	6.00	32	50	0.012	2.064	250mA-8A	100/250	1206
PF1206F7	7.00	32	50	0.010	2.720	250mA-8A	100/250	1206
PF1206F8	8.00	32	50	0.008	4.630	250mA-8A	100/250	1206
Note: Opening Time – 4 Hours Minimum, 5 seconds Maximum. Ceramic and glass package.								
PF1206H1	1.00	63	50	0.41	0.10	1A-7A	100/200/1000	1206
PF1206H1.25	1.25	63	50	0.25	0.22	1A-7A	100/200/1000	1206
PF1206H1.5	1.50	63	50	0.20	0.26	1A-7A	100/200/1000	1206
PF1206H2	2.00	63	50	0.13	0.67	1A-7A	100/200/1000	1206
PF1206H2.5	2.50	32	50	0.081	0.97	1A-7A	100/200/1000	1206
PF1206H3	3.00	32	50	0.052	1.20	1A-7A	100/200/1000	1206
PF1206H3.5	3.50	32	50	0.040	1.64	1A-7A	100/200/1000	1206
PF1206H4	4.00	32	50	0.03	2.43	1A-7A	100/200/1000	1206
PF1206H4.5	4.50	32	50	0.025	3.50	1A-7A	100/200/1000	1206
PF1206H5	5.00	32	50	0.02	5.45	1A-7A	100/200/1000	1206
PF1206H5.5	5.50	24	60	0.016	6.20	1A-7A	100/200/1000	1206
PF1206H6	6.00	24	60	0.013	8.10	1A-7A	100/200/1000	1206
PF1206H7	7.00	24	60	0.012	9.88	1A-7A	100/200/1000	1206
Note: Opening Time – 4 Hours Minimum, 1~60 seconds, 0.0002~0.02 seconds. Ceramic and glass package.								

OVERCURRENT PROTECTION: FUSES

PART NUMBER	CURRENT RATING Amps	VOLTAGE RATING Volts DC	INTERRUPTING RATING Amps DC	TYPICAL RESISTANCE Ohms	TYPICAL MELT t_{1t} DC(A ² s)	AMPERE RATING	%OF AMP RATING	PACKAGE
PF1206S1	1.00	63	50	0.42	0.10	1A-7A	100/200/300/800	1206
PF1206S1.25	1.25	63	50	0.25	0.22	1A-7A	100/200/300/800	1206
PF1206S1.5	1.50	63	50	0.21	0.25	1A-7A	100/200/300/800	1206
PF1206S2	2.00	63	50	0.13	0.59	1A-7A	100/200/300/800	1206
PF1206S2.5	2.50	32	50	0.08	0.88	1A-7A	100/200/300/800	1206
PF1206S3	3.00	32	50	0.05	1.10	1A-7A	100/200/300/800	1206
PF1206S3.5	3.50	32	50	0.036	1.55	1A-7A	100/200/300/800	1206
PF1206S4	4.00	32	50	0.03	2.30	1A-7A	100/200/300/800	1206
PF1206S4.5	4.50	32	50	0.025	3.55	1A-7A	100/200/300/800	1206
PF1206S5	5.00	32	50	0.02	5.40	1A-7A	100/200/300/800	1206
PF1206S5.5	5.50	24	60	0.016	6.20	1A-7A	100/200/300/800	1206
PF1206S6	6.00	24	60	0.013	8.10	1A-7A	100/200/300/800	1206
PF1206S7	7.00	24	60	0.012	9.88	1A-7A	100/200/300/800	1206



Note: Opening Time – 4 Hours Minimum, 1~120 seconds, 0.1~3 seconds, 0.001~0.05 seconds. Ceramic and glass package.

OVERCURRENT PROTECTION: POLYMER PTC DEVICES

PART NUMBER	MAX. HOLDING CURRENT – I_H Amps	MIN. TRIP CURRENT – I_T Amps	MAX. INTERRUPT VOLTAGE – V_{MAX} Volts	MAX. FAULT CURRENT – I_{MAX} Amps	MAX. TIME-TO- TRIP T_{TRIP} Amps @ Secs	TYPICAL POWER DISSIPATION – P_D Watts	MAX. RESISTANCE – R_{MAX} Ohms	PACKAGE
PMPS012-E-1206	0.125	0.37	30	100	1.0A @ 0.20s	0.60	6.00	1206
Note: Consult factory for other voltages in the PMPS-E-1206 Series								
PMPS370-E-1206	3.70	7.40	6	50	18.5A @ 2.00s	1.0	0.014	1206
PMPS020-FH-1206	0.20	0.40	30	100	8.0A @ 0.10s	0.60	0.600	1206
PMPS075-1812	0.75	1.50	24	100	8.0A @ 0.20s	0.60	0.350	1812
PMPS150-1812	1.50	3.00	24	20	8.0A @ 1.50s	0.80	0.110	1812
PMPS150E-1206	1.50	3.00	8	100	8.0A @ 0.30s	0.80	0.120	1206
PMPS200-1812	2.00	3.50	8	100	8.0A @ 2.00s	0.80	0.070	1812
PMPS200D-1210	2.00	4.00	6	50	8.0A @ 5.00s	1.2	0.028	1210
PMPS260C-1812	2.60	5.00	8	100	8.0A @ 4.00s	0.8	0.040	1812
PMPS380E-1206	3.80	7.60	6	50	16.0A @ 5.00s	1.2	0.015	1206

OVERCURRENT PROTECTION: POLYMER PTC DEVICES

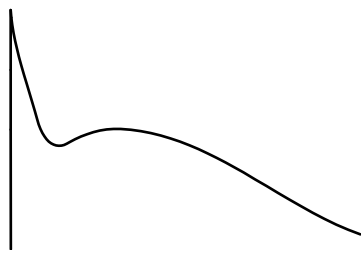
PART NUMBER	HOLDING CURRENT – I_H Amps	TRIP CURRENT – I_T Amps	OPERATING VOLTAGE – V_{DC} Volts	INTERRUPT CURRENT – I_{MAX} Amps	MAX. TIME- TO-TRIP @ 5 I_H A – T_{TRIP} SECONDS	MAX. POWER DISSIPATION – P_D Watts	TYPICAL RESISTANCE – R Ohms	PACKAGE
PLRO1206-300	3.0	6.0	6	50	4.0	1.0	0.008	1206
PLRO1206-380	3.0	8.0	6	50	4.0	1.0	0.006	1206
PLRO1210-190	1.9	4.9	6	50	4.0	1.0	0.013	1210
PLRO1210-300	3.0	8.0	6	50	4.0	1.0	0.009	1210
PLRO1210-300	3.8	9.0	6	50	4.0	1.0	0.008	1210

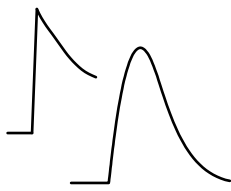
International Standard	Environmental Threat	Transient Characteristics	Test Waveform
61000-4-2	ESD	Super Fast < 1ns Low Energy	
61000-4-4	EFT	Fast 5 ns Medium Energy (per burst)	
61000-4-5	Surge	Surge 10-700 μs High Energy	

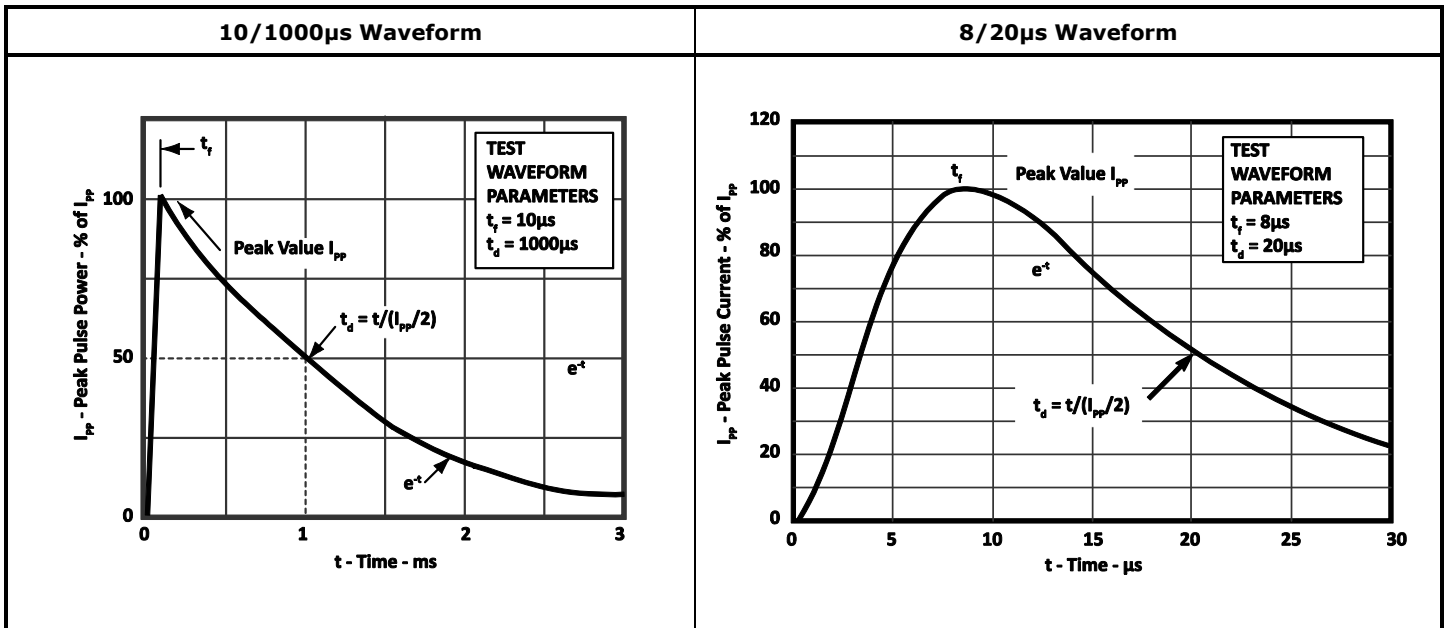

IMPULSE WAVE FORMS – UNIVERSAL WAVESHAPES

Impulses

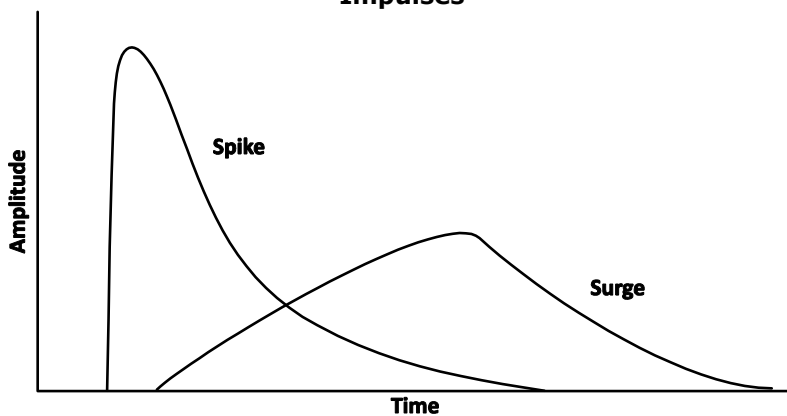

Damped Sinusoidal

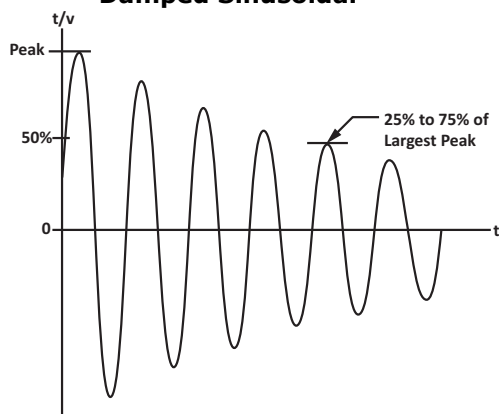

Peak Pulse Current (Amplitude)
 Pulse Duration (Time) – Spike
 Pulse Duration (Time) – Transient
 Pulse Duration (Time) – Surge

$I_t = I_{pp} = 10, 100, 1000 \text{ Amp}$
 $t_d = 30\text{ns (ESD)}$
 $t_d = 20 \text{ or } 1000\mu\text{s (Lightning)}$
 $t_d = 100\text{ms (Switching)}$

WAVEFORM 3a PIN INJECTION – 1MHz ($\pm 20\%$)(800kHz – 1200kHz Damped Sine Wave)

Level	V. Test (pk) in V	I Limit (pk) in A	DO-160G Waveform
1	107	4	
2	268	10	
3	655	24	
4	1620	60	
5	3450	128	

WAVEFORM 4 PIN INJECTION – 6.4μs/69.0μs (±20%)(5.12μs - 7.68μ)(55.2μs - 82.8μs)			
Level	Open Circuit Voltage in V	Short Circuit Current in A	DO-160G Waveform
1	53	10	
3	314	60	
5	1690	320	

WAVEFORM 5a PIN INJECTION – 40.0μs/120.0μs (±20%)(32.0μs - 48.0μs)(96.0μs - 144.0μs)			
Level	Open Circuit Voltage in V	Short Circuit Current in A	DO-160G Waveform
1	52	53	
2	128.4	136	
3	304	326	
4	758	800	
5	1630	1752	

PRODUCT PACKAGING

Nominal: Scaled 1"-1"



0402/U0402
 Width: 0.019" (0.48)
 Length: 0.039" (1.00)
 Height: 0.016" (0.41)
 LD Pitch: N/A
 Pad Count: 2



0406
 Width: 0.039" (1.00)
 Length: 0.039" (1.00)
 Height: 0.016" (0.41)
 LD Pitch: N/A
 Pad Count: 4



0406
 Width: 0.039" (1.00)
 Length: 0.059" (1.50)
 Height: 0.016" (0.41)
 LD Pitch: N/A
 Pad Count: 6



0408/U0408
 Width: 0.039" (1.00)
 Length: 0.079" (2.00)
 Height: 0.016" (0.41)
 LD Pitch: N/A
 Pad Count: 8



5 Bump FC
 Width: 0.038" (0.97)
 Length: 0.052" (1.32)
 Height: 0.016" (0.41)
 LD Pitch: N/A
 Pad Count: 5



C0201
 Width: 0.012" (0.30)
 Length: 0.024" (0.60)
 Height: 0.013" (0.33)
 LD Pitch: N/A
 Pad Count: 2



C0402
 Width: 0.022" (0.55)
 Length: 0.041" (1.05)
 Height: 0.014" (0.36)
 LD Pitch: N/A
 Pad Count: 2



CDIP-16
 Width: 0.47" (11.94)
 Length: 0.90" (22.86)
 Height: 0.192" (4.83)
 LD Pitch: 0.100" (2.54)
 Pin Count: 16



CG0402
 Width: 0.039" (1.00)
 Length: 0.039" (0.52)
 Height: 0.014" (0.35)
 LD Pitch: N/A
 Pad Count: 2



CG0603
 Width: 0.063" (1.60)
 Length: 0.031" (0.80)
 Height: 0.014" (0.35)
 LD Pitch: N/A
 Pad Count: 2



CG1206
 Width: 0.126" (3.20)
 Length: 0.063" (1.60)
 Height: 0.022" (0.55)
 LD Pitch: N/A
 Pad Count: 2



Chip Scale 0406
 Width: 0.040" (1.02)
 Length: 0.060" (1.52)
 Height: 0.009" (0.23)
 LD Pitch: N/A
 Pad Count: 6



DFN-2-0201(0603)
 Width: 0.012" (0.30)
 Length: 0.025" (0.64)
 Height: 0.012" (0.30)
 LD Pitch: N/A
 Pad Count: 2



DFN-2-0402
 Width: 0.024" (0.61)
 Length: 0.040" (1.02)
 Height: 0.018" (0.46)
 LD Pitch: N/A
 Pad Count: 2



DFN-2-3KW
 Width: 0.22" (5.59)
 Length: 0.25" (6.35)
 Height: 0.05" (1.27)
 LD Pitch: 0.168" (4.27)
 Pad Count: 2



DFN-2-5KW
 Width: 0.25" (6.35)
 Length: 0.30" (7.62)
 Height: 0.05" (1.27)
 LD Pitch: 0.189" (4.80)
 Pad Count: 2



DFN-4
 Width: 0.040" (1.02)
 Length: 0.040" (1.02)
 Height: 0.020" (0.50)
 LD Pitch: N/A
 Pad Count: 4



DFN-6
 Width: 0.059" (1.50)
 Length: 0.077" (1.96)
 Height: 0.019" (0.48)
 LD Pitch: 0.020" (0.50)
 Pad Count: 6



DFN-8
 Width: 0.079" (2.00)
 Length: 0.079" (2.00)
 Height: 0.031" (0.80)
 LD Pitch: 0.020" (0.50)
 Pad Count: 8



DFN-8LP
 Width: 0.063" (1.60)
 Length: 0.079" (2.00)
 Height: 0.022" (0.55)
 LD Pitch: 0.020" (0.50)
 Pad Count: 8



DFN-10
 Width: 0.101" (2.57)
 Length: 0.101" (2.57)
 Height: 0.019" (0.48)
 LD Pitch: 0.020" (0.50)
 Pad Count: 10



DFN-12
 Width: 0.063" (1.60)
 Length: 0.118" (3.00)
 Height: 0.022" (0.55)
 LD Pitch: 0.020" (0.50)
 Pad Count: 12



DFN-16
 Width: 0.063" (1.60)
 Length: 0.158" (4.00)
 Height: 0.031" (0.79)
 LD Pitch: 0.020" (0.50)
 Pad Count: 16



DFN-16LP
 Width: 0.063" (1.60)
 Length: 0.158" (4.00)
 Height: 0.022" (0.55)
 LD Pitch: 0.020" (0.50)
 Pad Count: 16



DFN-16SLP
 Width: 0.051" (1.30)
 Length: 0.158" (3.30)
 Height: 0.021" (0.53)
 LD Pitch: 0.020" (0.50)
 Pad Count: 16

PRODUCT PACKAGING SCALED 1"-1" Nominal



DIP-8
Width: 0.250" (6.35)
Length: 0.39" (9.91)
Height: 0.160" (4.06)
LD Pitch: 0.100" (2.54)
Pin Count: 8



DIP-14
Width: 0.250" (6.35)
Length: 0.740" (18.80)
Height: 0.160" (4.06)
LD Pitch: 0.100" (2.54)
Pin Count: 14



DIP-16
Width: 0.250" (6.35)
Length: 0.755" (19.18)
Height: 0.160" (4.06)
LD Pitch: 0.100" (2.54)
Pin Count: 16



DO-214AA
Width: 0.17" (4.32)
Length: 0.14" (3.56)
Height: 0.089" (2.25)
LD Pitch: N/A
Pin Count: 2



DO-214AB
Width: 0.27" (6.86)
Length: 0.23" (5.84)
Height: 0.089" (2.25)
LD Pitch: N/A
Pin Count: 2



DO-214AC
Width: 0.17" (4.32)
Length: 0.10" (2.54)
Height: 0.08" (2.03)
LD Pitch: N/A
Pin Count: 2

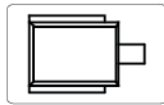

DO-218
Width: 0.40" (10.00)
Length: 0.60" (15.50)
Height: 0.19" (5.0)
LD Pitch: N/A
Pin Count: 1



E0503
Width: 0.030" (0.76)
Length: 0.050" (1.27)
Height: 0.030" (0.76)
LD Pitch: N/A
Pad Count: 2



P1206
Width: 0.13" (3.20)
Length: 0.065" (1.65)
Height: 0.04" (1.0)
LD Pitch: N/A
Pad Count: 2



P1210
Width: 0.13" (3.20)
Length: 0.10" (2.54)
Height: 0.02" (0.51)
LD Pitch: N/A
Pad Count: 2



P1812
Width: 0.18" (4.57)
Length: 0.11" (2.79)
Height: 0.035" (0.89)
LD Pitch: N/A
Pad Count: 2



QFN-16
Width: 0.118" (3.00)
Length: 0.118" (3.00)
Height: 0.030" (0.76)
LD Pitch: 0.020" (0.50)
Pad Count: 16



SC-70-5L
Width: 0.050" (1.27)
Length: 0.079" (2.00)
Height: 0.035" (0.89)
LD Pitch: 0.025" (0.64)
Pin Count: 5



SC-70-6L
Width: 0.050" (1.27)
Length: 0.079" (2.00)
Height: 0.035" (0.89)
LD Pitch: 0.025" (0.64)
Pin Count: 6



SC-79
Width: 0.032" (0.81)
Length: 0.046" (1.17)
Height: 0.024" (0.61)
LD Pitch: N/A
Pin Count: 2



SC-89
Width: 0.047" (1.19)
Length: 0.063" (1.60)
Height: 0.022" (0.55)
LD Pitch: 0.020" (0.50)
Pin Count: 6



SO-8
Width: 0.192" (4.90)
Length: 0.15" (3.81)
Height: 0.061" (1.55)
LD Pitch: 0.050" (1.27)
Pin Count: 8



SO-14
Width: 0.15" (3.81)
Length: 0.34" (8.63)
Height: 0.061" (1.55)
LD Pitch: 0.050" (1.27)
Pin Count: 14



SO-16
Width: 0.15" (3.81)
Length: 0.390" (9.90)
Height: 0.061" (1.55)
LD Pitch: 0.050" (1.27)
Pin Count: 16



SO-16WB
Width: 0.295" (7.50)
Length: 0.405" (10.30)
Height: 0.097" (2.46)
LD Pitch: 0.050" (1.27)
Pin Count: 16



SOD-323
Width: 0.051" (1.30)
Length: 0.69" (1.75)
Height: 0.037" (0.94)
LD Pitch: N/A
Pin Count: 2



SOD-723
Width: 0.024" (0.61)
Length: 0.040" (1.02)
Height: 0.022" (0.56)
LD Pitch: N/A
Pin Count: 2



SOD-923
Width: 0.024" (0.60)
Length: 0.031" (0.79)
Height: 0.015" (0.37)
LD Pitch: N/A
Pin Count: 2



SOT-143
Width: 0.051" (1.30)
Length: 0.115" (2.92)
Height: 0.039" (1.00)
LD Pitch: 0.075" (1.90)
Pin Count: 4



SOT-23
Width: 0.051" (1.30)
Length: 0.115" (2.92)
Height: 0.039" (1.00)
LD Pitch: 0.037" (0.95)
Pad Count: 3

PRODUCT PACKAGING SCALED 1"-1" Nominal



SOT-23-6
Width: 0.065" (1.65)
Length: 0.115" (2.92)
Height: 0.047" (1.19)
LD Pitch: 0.037" (0.95)
Pin Count: 6



SOT-543
Width: 0.047" (1.19)
Length: 0.063" (1.60)
Height: 0.022" (0.55)
LD Pitch: 0.020" (0.50)
Pin Count: 4



SOT-553
Width: 0.047" (1.19)
Length: 0.063" (1.60)
Height: 0.022" (0.55)
LD Pitch: 0.020" (0.50)
Pin Count: 5



SOT-563
Width: 0.047" (1.19)
Length: 0.063" (1.60)
Height: 0.022" (0.55)
LD Pitch: 0.020" (0.50)
Pin Count: 6



SOT-883
Width: 0.024" (0.50)
Length: 0.039" (1.00)
Height: 0.018" (0.45)
LD Pitch: 0.014" (0.36)
Pad Count: 3



SOT-953
Width: 0.031" (0.79)
Length: 0.039" (1.00)
Height: 0.018" (0.46)
LD Pitch: 0.015" (0.38)
Pin Count: 5



SOT-963
Width: 0.031" (0.79)
Length: 0.039" (1.00)
Height: 0.018" (0.46)
LD Pitch: 0.015" (0.38)
Pin Count: 6

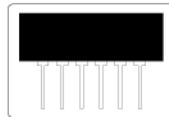

VSIP-6
Width: 0.250" (6.35)
Length: 0.780" (19.18)
Height: 0.130" (3.30)
LD Pitch: 0.100" (2.54)
Pin Count: 6



VSIP-10
Width: 0.250" (6.35)
Length: 1.020" (25.90)
Height: 0.110" (2.79)
LD Pitch: 0.100" (2.54)
Pin Count: 10

Not all packages are shown. Please consult factory for all available packages.

COMPANY PROFILE

In business more than 25 years, ProTek Devices™ is a privately held semiconductor company. The company offers a product line of overvoltage protection and overcurrent protection components. These include transient voltage suppressor array (TVS arrays) avalanche breakdown diode, steering diode TVS array and electronics SMD chip fuses. These components deliver circuit protection in electronic systems from numerous overvoltage and overcurrent events. They include lightning; electrostatic discharge (ESD); nuclear electromagnetic pulses (NEMP); inductive switching; and electromagnetic interference (EMI) / radio frequency interference (RFI). ProTek Devices also offers LED wafer die for ESD protection and related high frequency products. ProTek Devices is ISO 9001:2015 certified.

CONTACT US

Corporate Headquarters

2929 South Fair Lane
Tempe, Arizona 85282
USA

By Telephone

General: 602-431-8101
Sales: & Marketing: 602-414-5109
Customer Service: 602-414-5114
Product Technical Support: 602-414-5107

By Fax

General: 602-431-2288

By E-mail:

Asia Sales: asiasales@protekdevices.com
Europe Sales: europesales@protekdevices.com
U.S. Sales: ussales@protekdevices.com
Distributor Sales: distysales@protekdevices.com
Customer Service: service@protekdevices.com
Technical Support: support@protekdevices.com

ProTek Devices (Asia Pacific) Pte. Ltd.

8 Ubi Road 2, #06-19
Zervex
Singapore - 408538
Tel: +65-67488312
Fax: +65-67488313

Web

www.protekdevices.com

COPYRIGHT © ProTek Devices 2019 - This literature is subject to all applicable copyright laws and is not for resale in any manner.

SPECIFICATIONS: ProTek reserves the right to change the electrical and or mechanical characteristics described herein without notice.

DESIGN CHANGES: ProTek reserves the right to discontinue product lines without notice and that the final judgement concerning selection and specifications is the buyer's and that in furnishing engineering and technical assistance. ProTek assumes no responsibility with respect to the selection or specifications of such products. ProTek makes no warranty, representation or guarantee regarding the suitability of its products for any particular purpose, nor does ProTek assume any liability arising out of the application or use of any product or circuit and specifically disclaims any and all liability without limitation special, consequential or incidental damages.

LIFE SUPPORT POLICY: ProTek Devices products are not authorized for use in life support systems without written consent from the factory.

