

MOLDING TYPE INDUCTOR

SPEC. NO. D-0630-001-I

Introductions

The CIP series power inductors are surface-mount molding type which widely used in the applications such as DC/DC converters in Notebook, Netbook, desktop and server and low profile, high current power supplies.

Features

- * Operating temperature -55 to +125 °C.
- * High performance (saturation current) due to powdered iron composition.
- * Low loss due to design of low DC resistance.
- * Frequency application up to 3MHz.
- * Low profile with max thickness 3.0mm.
- * 100% lead free and meteed RoHS standard.
- * Excellent solderability and resistance to soldering heat .
- * Suitable for reflow soldering..
- * High reliability and easy surface mount assembly.

Part Number Code

CIP	0630	HI	1R0	M
1	2	3	4	5

1 Product Type

2 Dimension

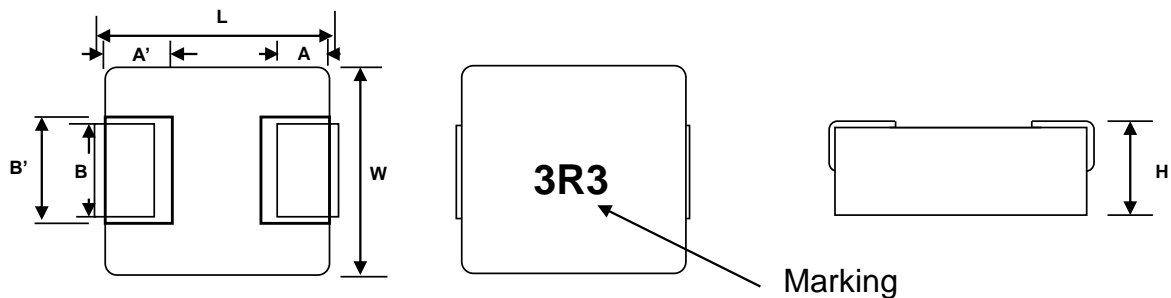

L:	7.2 ±0.3 mm	A:	1.6 ±0.4 mm
W:	6.65 ±0.2 mm	A':	2.0 ±0.1 mm
H:	3.0mm max.	B:	3.0 ±0.3 mm
		B':	3.4 ±0.2 mm

Marking

HI series	3R3
LR series	LR 3R3

3 Application

HI	High Saturation Current
LR	Low DC Resistance

4 Inductance Value

1R0 = 1.0μH	3R3 = 3.3μH
1R5 = 1.5μH	6R8 = 6.8μH
2R2 = 2.2μH	100 = 10μH

5 Tolerance

M	=	± 20 %
N	=	± 30 %

MOLDING TYPE INDUCTOR

SPEC. NO. D-0630-001-I

Scope

This specification applies to fixed inductors of the following types used in electronic equipment :

- LR Type : For low power application with lower DC resistance and lower power loss design requirement.
- HI Type : For higher high performance application with higher saturation current requirement.

Construction

Configuration

& Dimension : Please refer to the attached figures and tables.

Operating Temperature Range

Operating Temperature Range is the scope of ambient temperature at which the inductor can be operated continuously at rated current.

Temp. Range : - 55°C to + 125°C

Characteristics

Standard Atmospheric Conditions

Unless otherwise specified, the standard range of atmospheric conditions for making measurements and tests are as follows :

Ambient Temperature : 25 °C (20 °C) ± 2 °C

Relative Humidity : 60% to 70%

Air Pressure : 86 Kpa to 106 Kpa

MOLDING TYPE INDUCTOR

Recommended Soldering Conditions (Please use this product by reflow soldering)

a. Recommended Reflow temperature profile

(Temperature of the mounted parts surface on the printed circuit board)

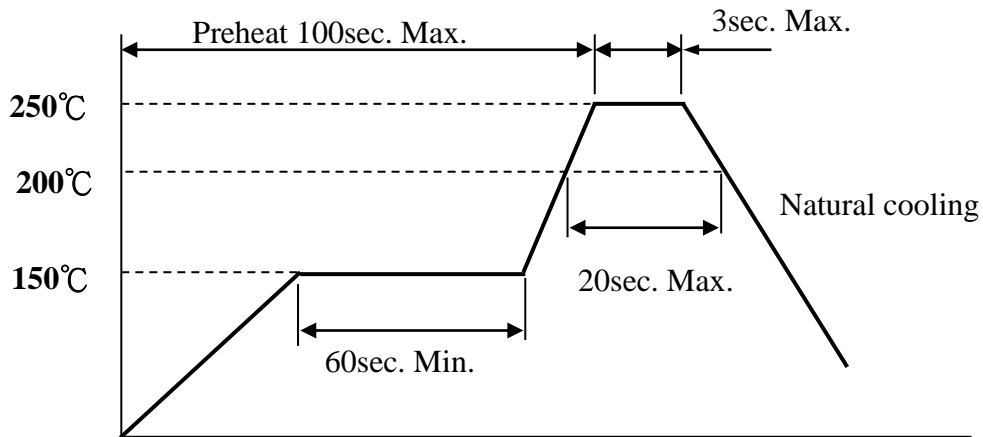

b. Dip temperature

Use a solder iron of less than 30W when soldering, do not allow the soldering iron tip directly touch the ferrite body outside of terminal electrode.

2 seconds max. at 260°C.

c. Recommended Footprint

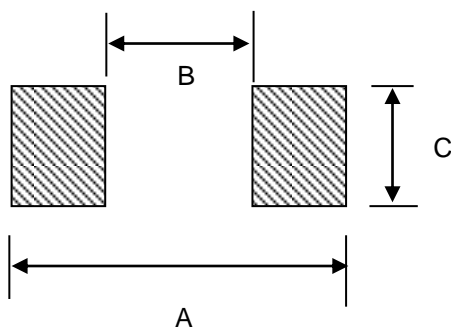

A	8.4mm
B	3.7mm
C	3.4mm

CIP 0630 HI SERIES Specification

Part No.					Inductance ¹	Percent ²	DCR ³		Isat ⁴	Irat ⁵
					(μ H)	Tolerance	Typ. (m Ω)	Max. (m Ω)	(A)	(A)
CIP	0630	HI	1R0	-	1.0	M	9.0	10.0	20.5	11.0
CIP	0630	HI	1R5	-	1.5	M	14.0	15.0	17.0	9.0
CIP	0630	HI	2R2	-	2.2	M	18.0	20.0	14.0	8.0
CIP	0630	HI	3R3	-	3.3	M	28.0	30.0	13.5	6.8
CIP	0630	HI	4R7	-	4.7	M	37.0	40.0	10.0	5.5
CIP	0630	HI	6R8	-	6.8	M	54.0	60.0	8.0	4.5
CIP	630	HI	8R2	-	8.2	M	64.0	68.0	7.5	4.0
CIP	0630	HI	100	-	10.0	M	102.0	105.0	7.0	3.0

1. Inductance is measured in HP-4284A Precision LCR Meter under 100kHz, 0.25V.

2. Tolerance : M =20% , N=30%.

3. RDC is measured in HP 4338B mill ohm meter.(or equivalent).

4. Isat : Based on inductance change ($\Delta L/L_0$: \leq -20%)

5. Irat : Based on temperature rise (ΔT : 40°C TYP.)

PRODUCT SPECIFICATION

SPEC. NO. D-0630-001-I

CIP0630HI1R0

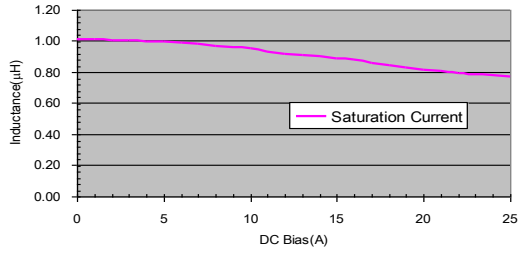

CIP0630HI1R0

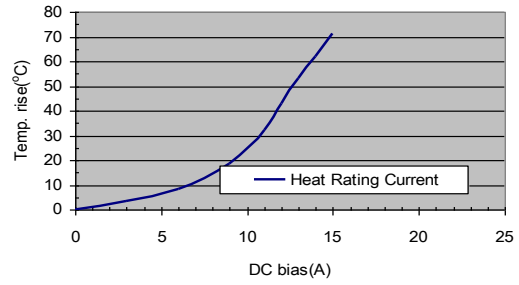

CIP0630HI1R5

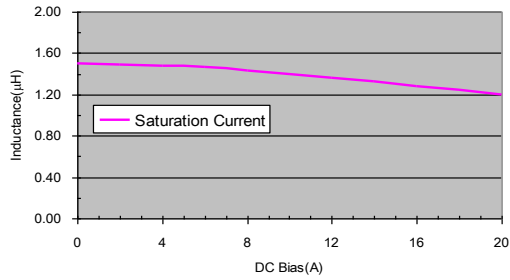

CIP0630HI1R5

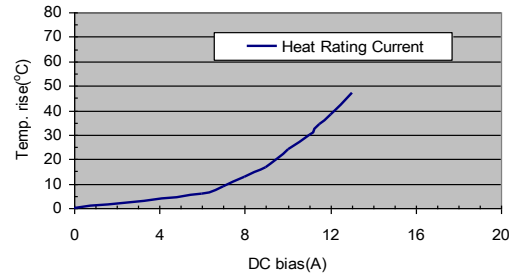

CIP0630HI2R2

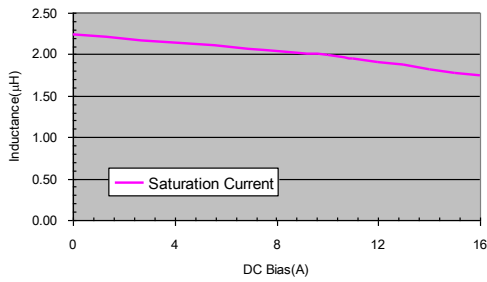

CIP0630HI2R2

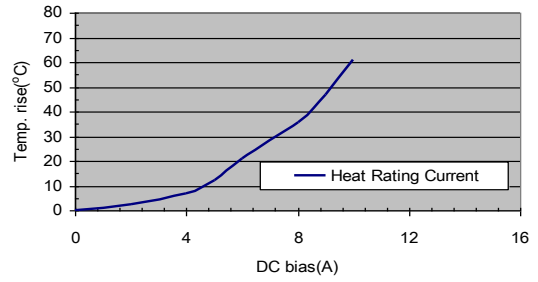

CIP0630HI3R3

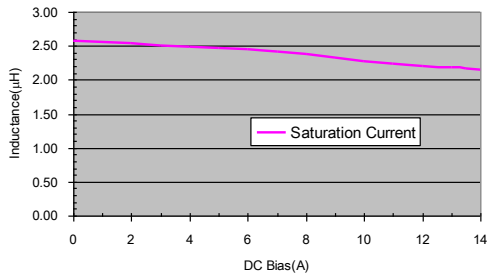

CIP0630HI3R3

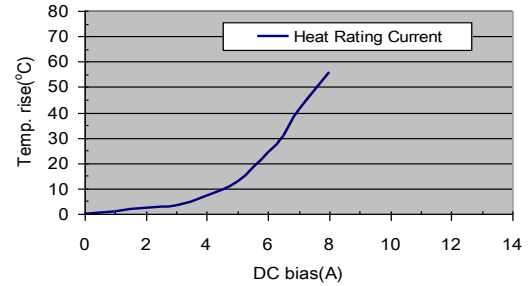

CIP0630HI4R7

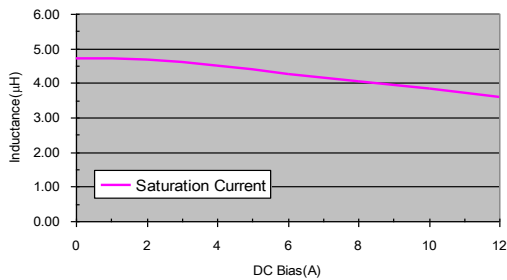

CIP0630HI4R7

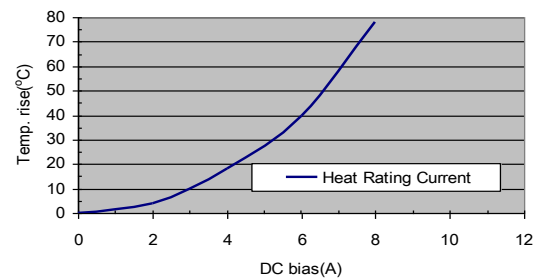

CIP0630HI6R8

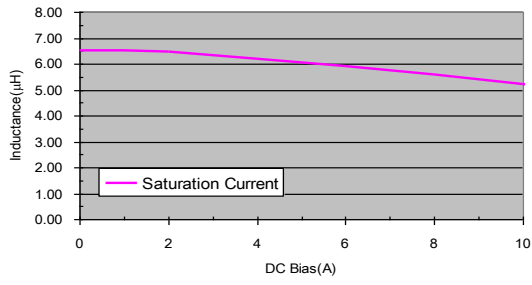

CIP0630HI6R8

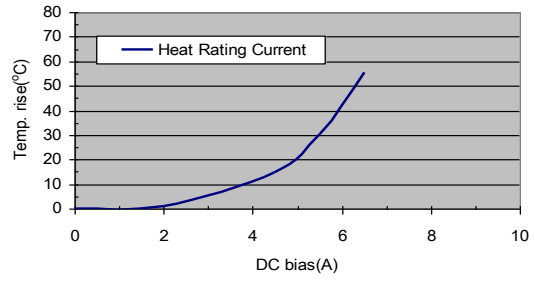

CIP0630HI8R2

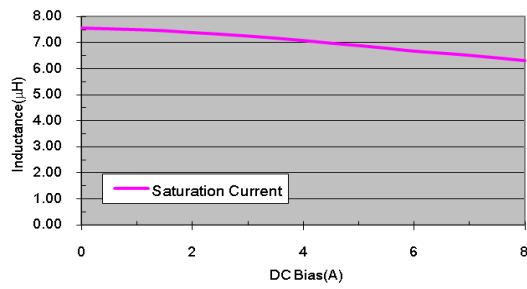

CIP0630HI8R2

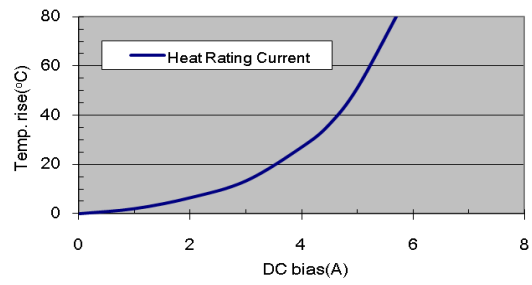

CIP0630HI100

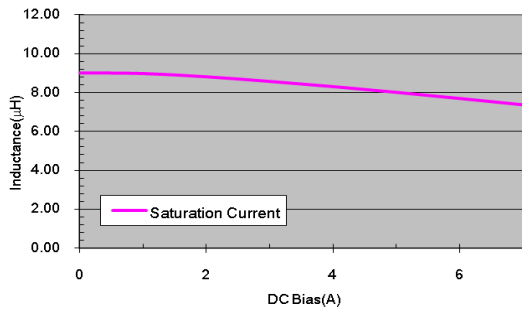

CIP0630HI100

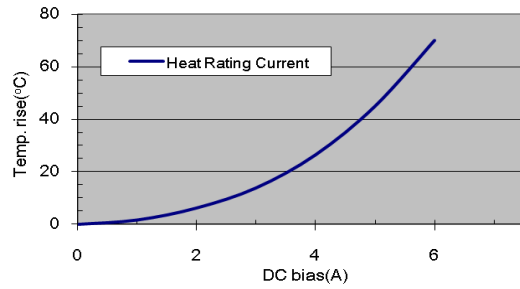

Reliability Test

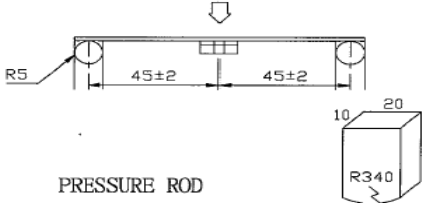
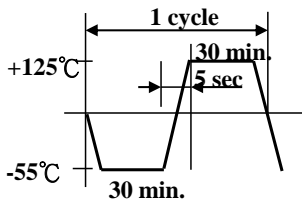
Item	Specifications	Test conditions
Solderability	The metalized area shall have 95% minimum solder coverage.	1. Preheating at $160 \pm 10^\circ\text{C}$ 90sec 2. $245^\circ\text{C} \pm 5^\circ\text{C}$ for 2 ± 1 sec
Substrate Bending	$\Delta L/L_0 : \leq \pm 5\%$ There shall be no mechanical damage or electrical damage.	The sample shall be soldered onto the printed circuit board and a load applied until the figure in the arrow direction is made approximately 2mm(keep time 5 ± 1 seconds) F(Pressurization) 
Vibration	$\Delta L/L_0 : \leq \pm 5\%$ There shall be no mechanical damage	Solder specimen inductor on the test printed circuit board. Apply vibrations in each of the x,y and z directions for 2 hours for a total of 6 hours. Frequency : 10~55~10Hz in 60sec as a period Amplitude : 1.5mm
High Temperature Storage	$\Delta L/L_0 : \leq \pm 5\%$ There shall be no mechanical damage or electrical damage.	The sample shall be left for 96 hours in an atmosphere with a temperature of $85 \pm 2^\circ\text{C}$ and a normal humidity. Upon completion of the measurement shall be made after the sample has been left in a normal temperature and normal humidity for 1 hour.
Low Temperature Storage	$\Delta L/L_0 : \leq \pm 5\%$ There shall be no mechanical damage or electrical damage.	The sample shall be left for 96 hours in an atmosphere with a temperature of $-40 \pm 2^\circ\text{C}$. Upon completion of the test, the measurement shall be made after the sample has been left in a normal temperature and normal humidity for 1 hour.
Thermal Shock	$\Delta L/L_0 : \leq \pm 5\%$ There shall be no damage problems.	The sample shall be subject to 10 continuous cycles, such as shown in the following temperature cycle:  Measure the test items after leaving the inductors at room temperature and humidity for 1 hours.
Moisture storage	$\Delta L/L_0 : \leq \pm 5\%$ There shall be no mechanical damage.	The sample shall be left for 96 hours in a temperature of $60 \pm 2^\circ\text{C}$ and a humidity(RH) of 90~95%. Upon completion of the test, the measurement shall be made after the sample has been left in a normal temperature and normal humidity more than 1 hour.

PRODUCT SPECIFICATION

SPEC. NO. D-0630-001-I

Packaging

The packaging must be done not to receive any damage during transporting and storing.

1. Tape dimensions

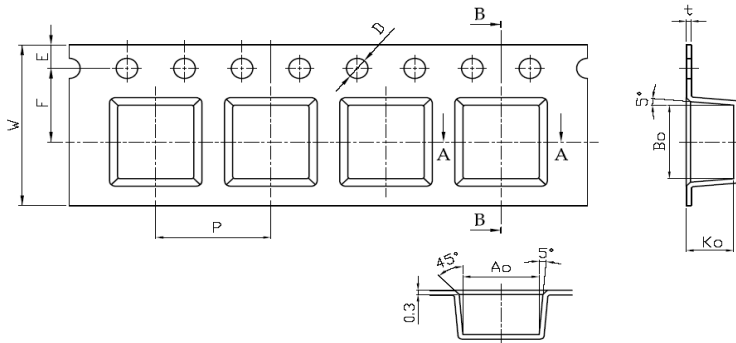

unit:mm

	0530	0630
A0	5.3	7.2
B0	5.5	7.5
K0	3.3	3.6
P	8.0	12.0
t	0.4	0.3
W	12	16
E	1.75	1.75
F	5.5	7.5
D	1.5	1.5

2. Reel dimensions

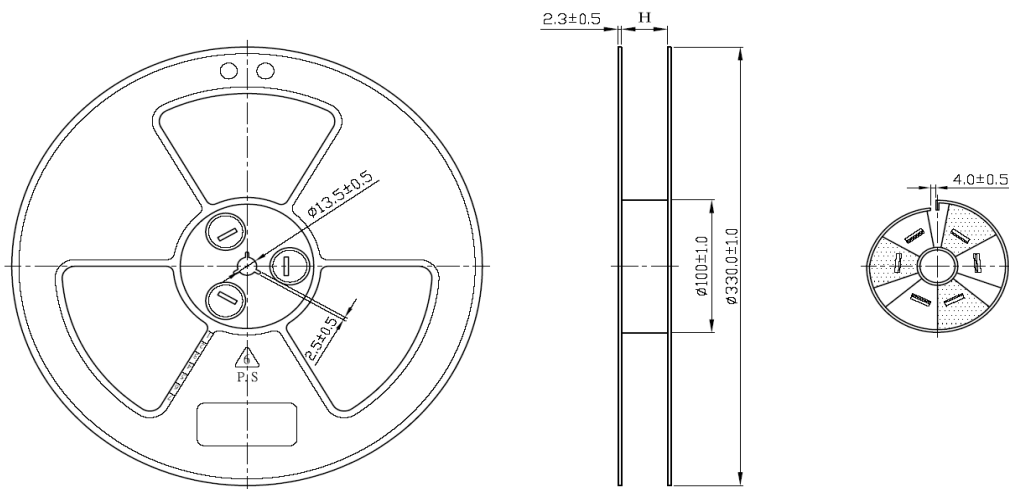

3. Tapping figure

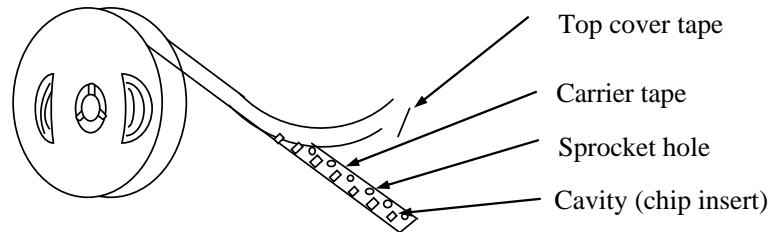

4. Packaging Form

There shall not continuation more than two vacancies of the product.

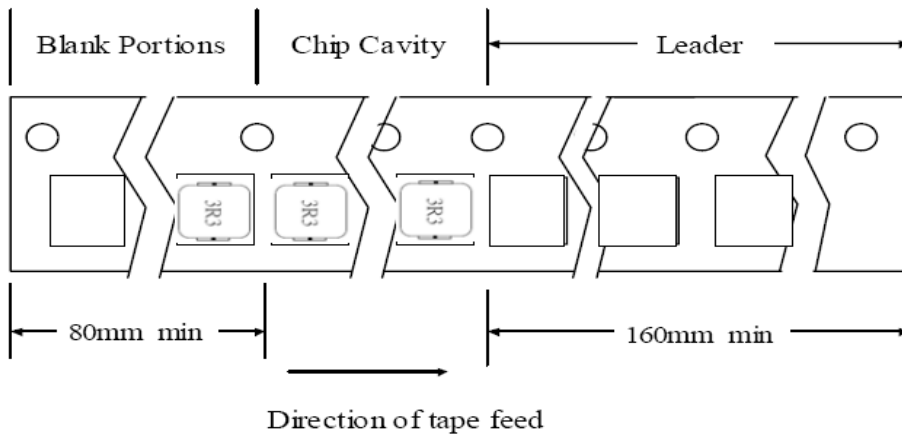

5. Packing Quantity

Quantity : ϕ 330 mm reel type : 1500 pcs./reel
4 reels/ Inner Carton, 4 Inner Carton/ Master Carton
24,000 pcs. Min quantity per lot.