

# 2JE21

## 5GNR Surface Mount

### Key Features

#### 5GNR

- 617-960 MHz
- 1427-2690 MHz
- 3300-5000 MHz
- 5150-5925 MHz

Surface Mount

High Performance

Fiberglass Material

Ground Plane Dependent

Dimensions 40 x 7 x 3 mm



## 1. Antenna and electrical specifications

Parameters	5GNR Antenna			
<b>Technologies</b>	5G, 4G, 3G and 2G			
<b>Standards</b>	5GNR/4GLTE/FirstNet/CBRS/LPWA/CAT-X/CAT-Mx/CAT-NBx/NB-IoT/3G/2G			
<b>Frequency (MHz)</b>	617-960	1427-2690	3300-5000	5150-5925
<b>Band (MHz)</b>	600, 700, 850, 900	1500, 1600, 1700, 1800, 1900, 2000, 2100, 2300, 2500, 2600	3300, 3500, 3600, 3700, 4500	5200, 5500, 5800
<b>5GNR Bands</b>	n5, n8, 12, n20, n28, n71, n81, n82, n83,	n1, n2, n3, n7, n25, n34, n38, n39, n40, n41, n50, n51, n66, n70, n74, n75, n76, n80, n84, n86	n77, n78, n79	
<b>4GLTE Bands</b>	B5, B6, B8, B12, B13, B14, B17, B18, B19, B20, B26, B27, B28, B29, B44, B67, B68, B71, B85	B1, B2, B3, B4, B7, B9, B10, B11, B21, B23, B24, B25, B30, B32, B33, B34, B35, B36, B37, B38, B39, B40, B41, B45, B50, B51, B65, B66, B69, B70, B74, B75, B76	B22, B42, B43, B48, B49, B52	B46, B47, B252, B255
<b>3GCELL Bands</b>	B5, B6, B8, B12, B13, B14, B19, B20, B26	B1, B2, B3, B4, B7, B9, B10, B11, B21, B25, B32, B33, B34, B35, B36, B37, B38, B39, B40	B22	
<b>2GCELL Bands</b>	710, 750, 810T, 850, 900P, 900E, 900R	1800DCS, 1900PCS		
<b>CDMACELL Bands</b>	BC0, BC2, BC3, BC7, BC9, BC10, BC12, BC18, BC19	BC1, BC4, BC6, BC8, BC13, BC14, BC15, BC16, BC20, BC21		
<b>Return Loss (dB)</b>	~-6.6	~-9.0	~-6.6	~-7.9
<b>VSWR</b>	~3.0:1	~2.3:1	~2.8:1	~2.4:1
<b>Efficiency (%)</b>	~53.0	~60.8	~45.3	~43.1
<b>Peak Gain (dBi)</b>	~1.4	~3.3	~2.9	~1.8
<b>Average Gain (dB)</b>	~-2.8	~-2.2	~-3.5	~-3.7
<b>Impedance (Ohm)</b>	50			
<b>Polarisation</b>	Linear			
<b>Radiation Pattern</b>	Omni-Directional			
<b>Max. Input Power (W)</b>	25			

### Antenna Measurement Conditions:

Mounted on ground plane of 120 x 40.4 mm

Measured in Certified CTIA 3D Anechoic Chamber

## 2. Mechanical and environmental specifications

Specifications	2JE21
<b>Mounting Type</b>	Surface Mount
<b>Dimensions (mm)</b>	40 x 7 x 3
<b>Material</b>	Fiberglass
<b>Operating Temperature (C)</b>	-40 to +85
<b>Storage Temperature (C)</b>	-40 to +85
<b>Storage Relative Humidity (%)</b>	Up to 93 at 30 C
<b>Substance Compliance</b>	RoHS
<b>Shear Force Test</b>	Minimum specified shear force: 25 kgf according to Relevant Standards for Tests: IEC62137-1-2 (2007)

### 3. Antenna parameters

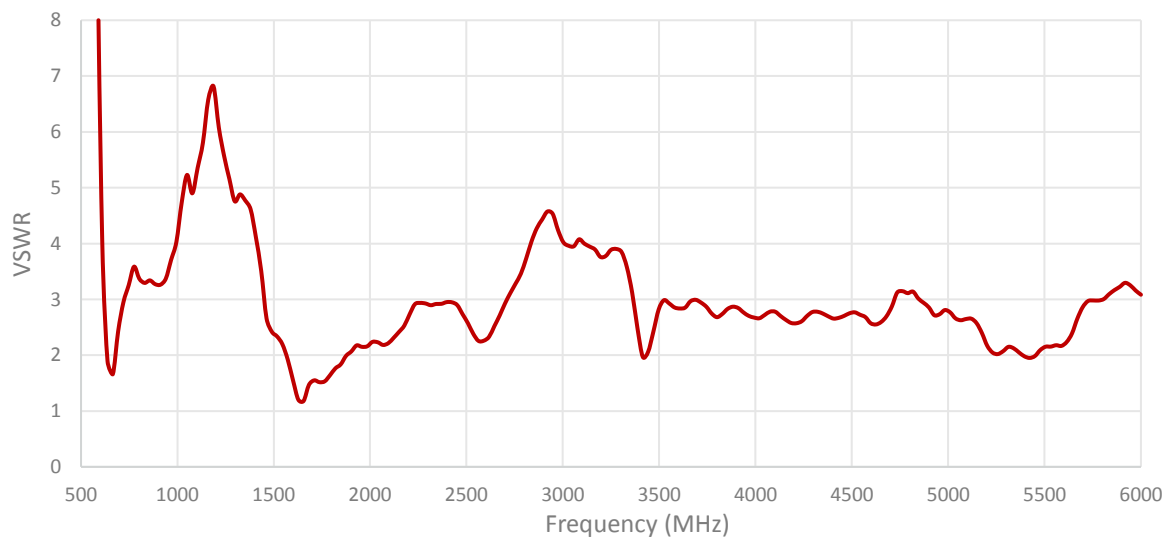
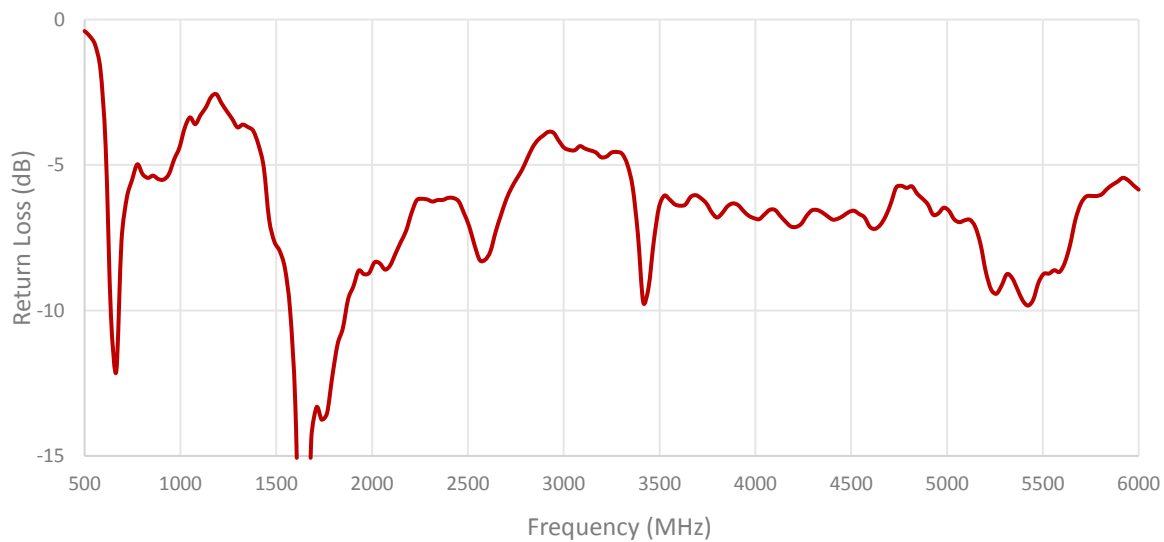

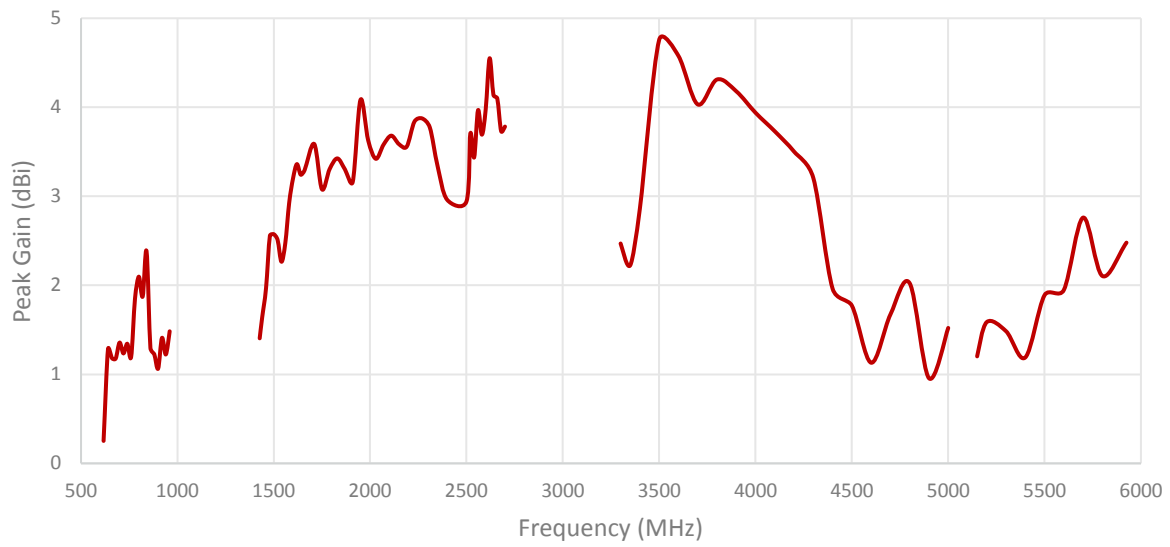
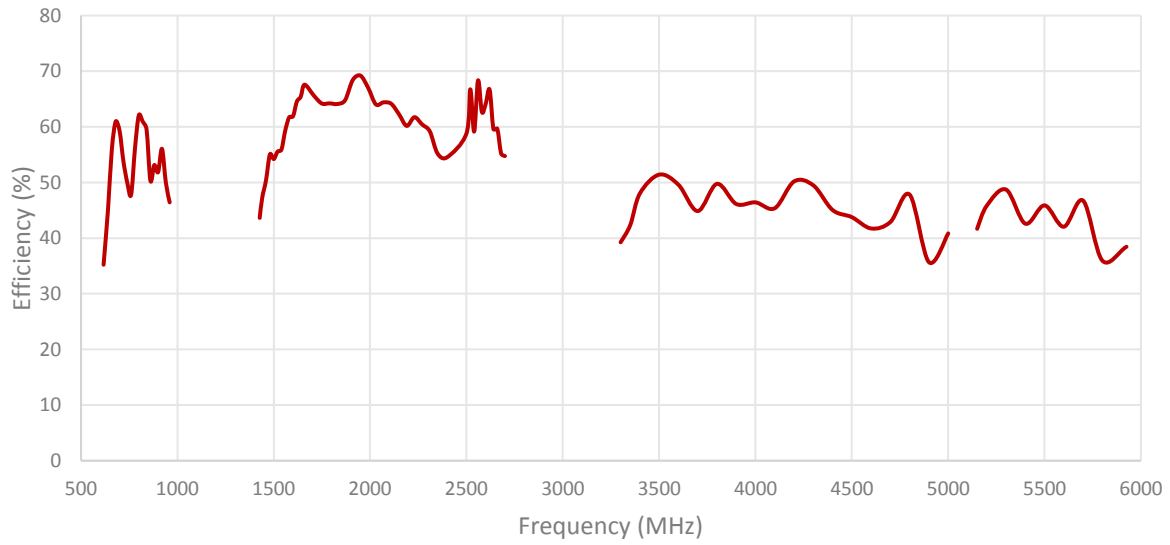

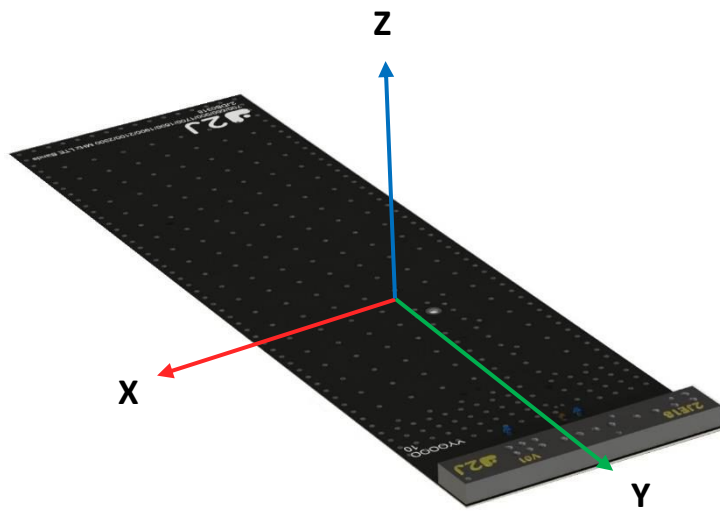
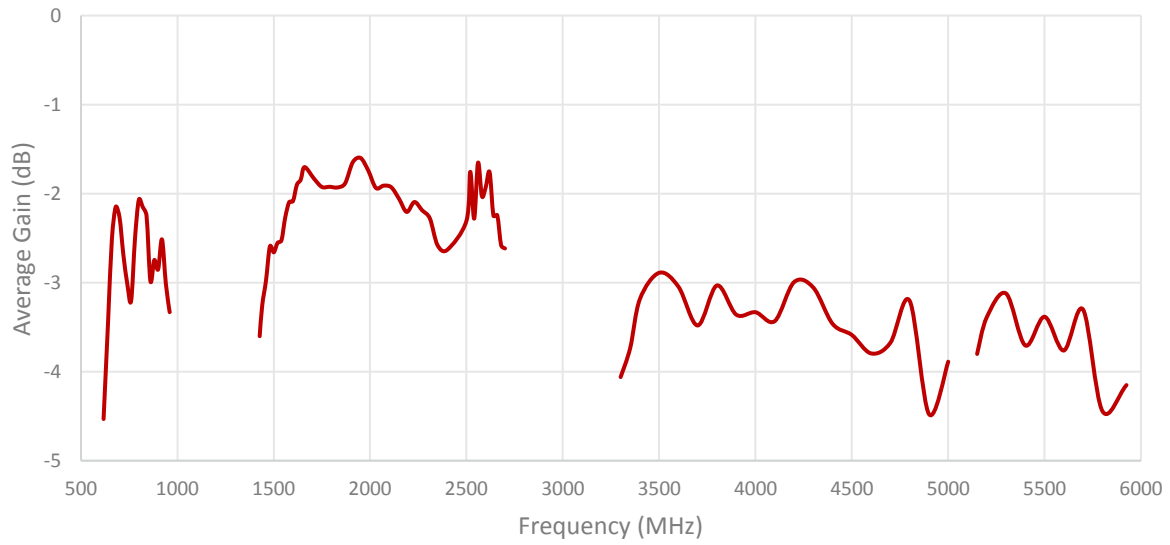

Radiation pattern reference

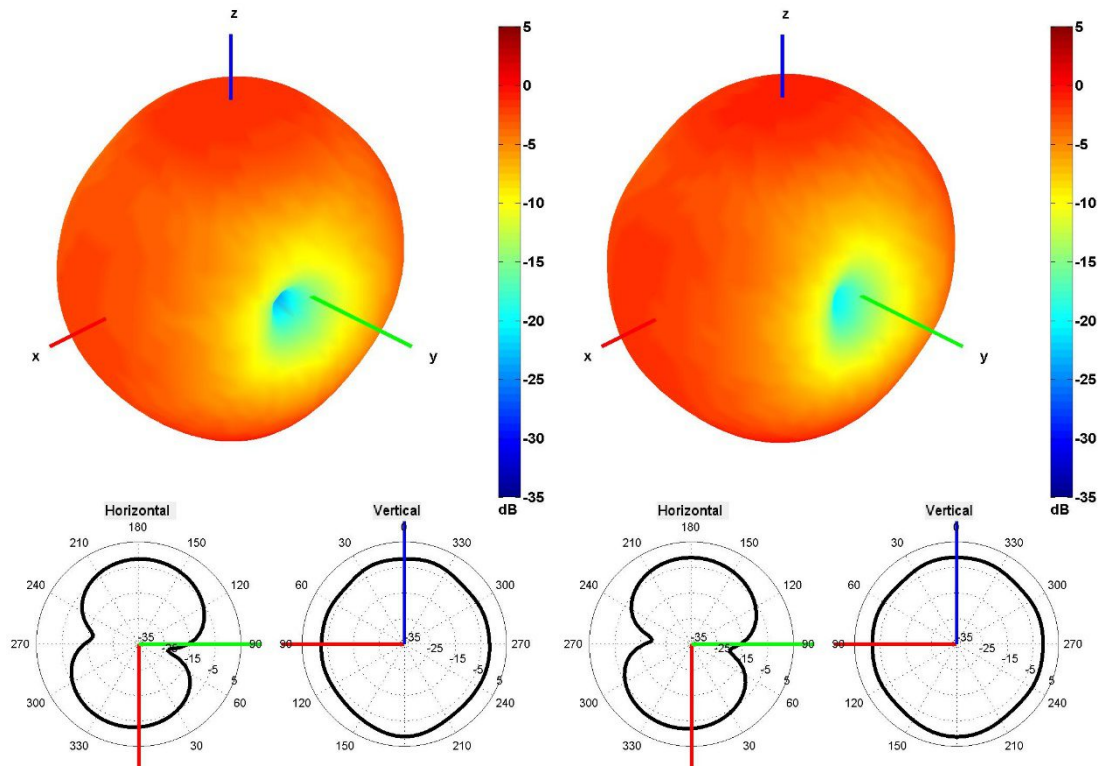

650 and 750 MHz Radiation pattern

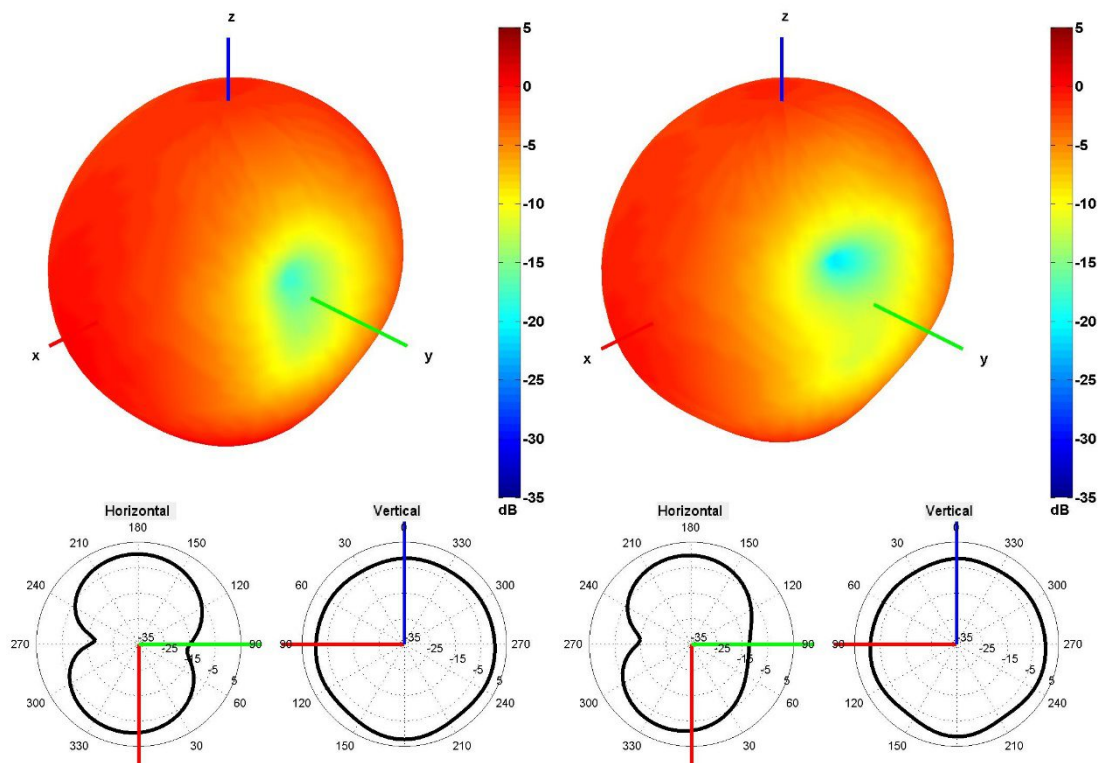

850 and 940 MHz Radiation pattern

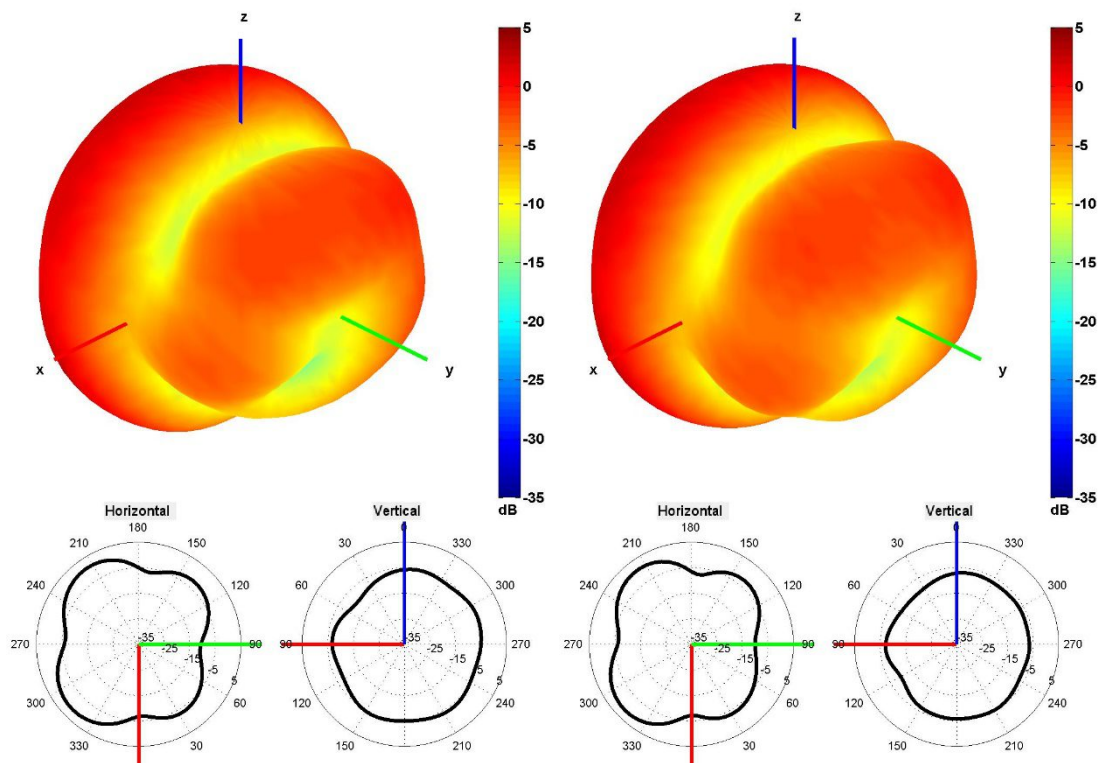
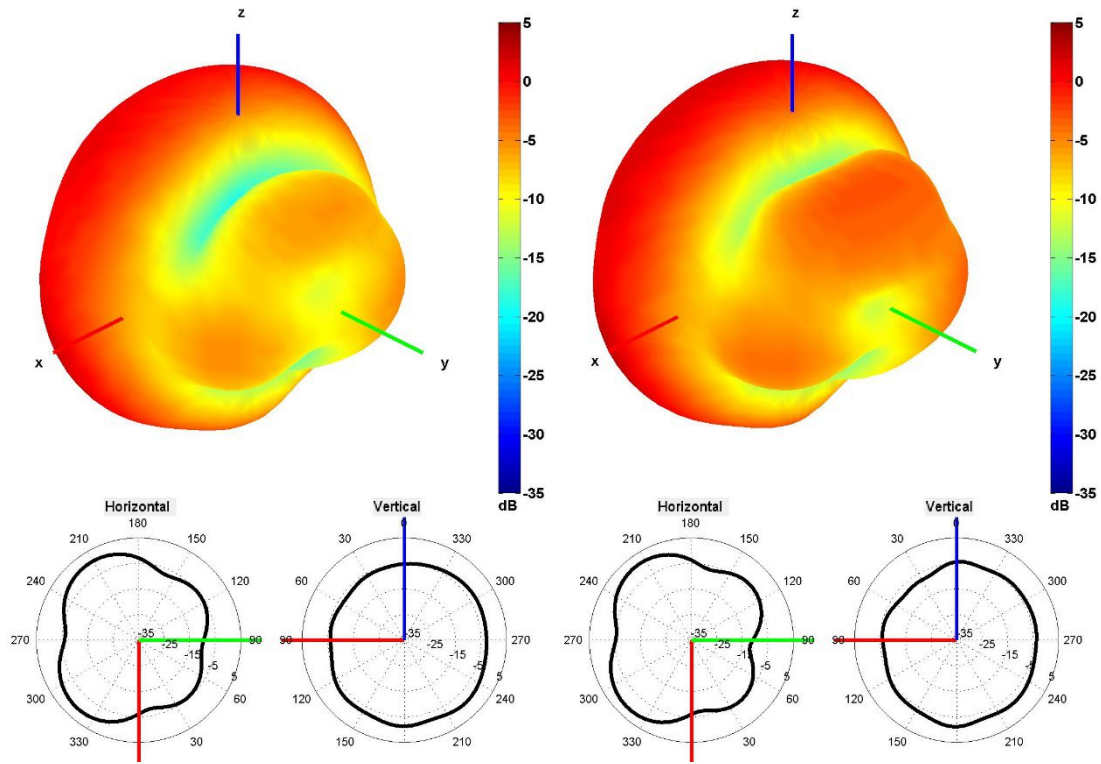



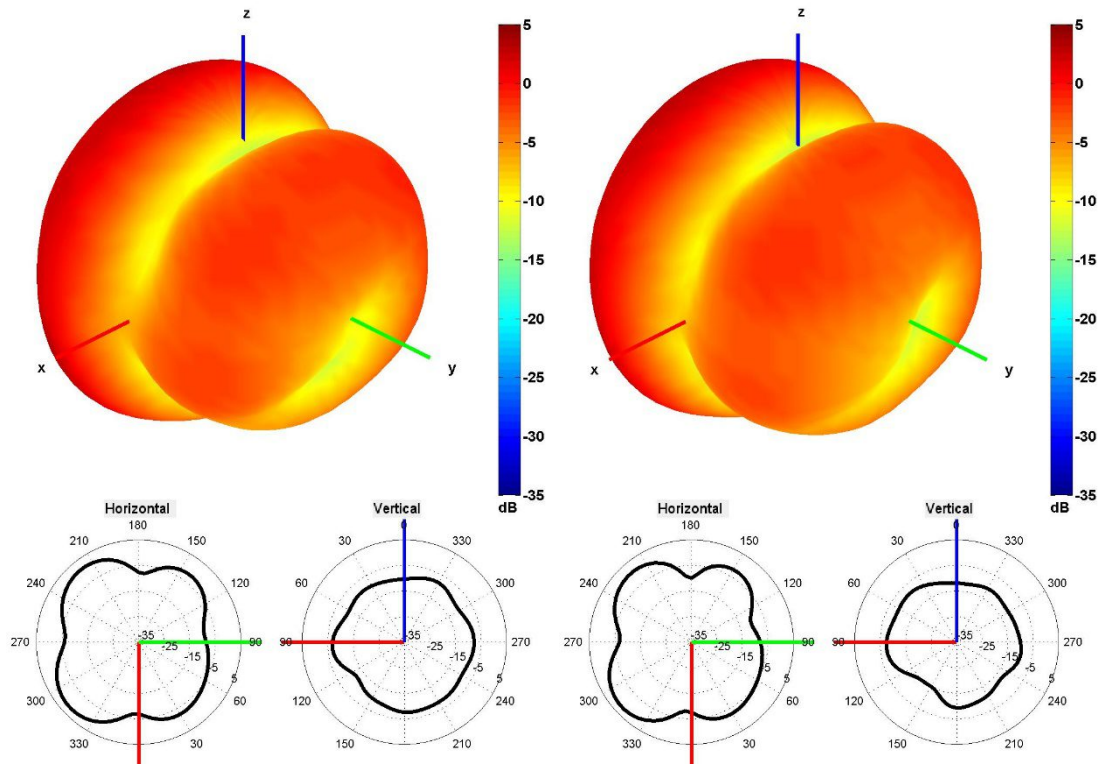

1950 and 2100 MHz Radiation pattern

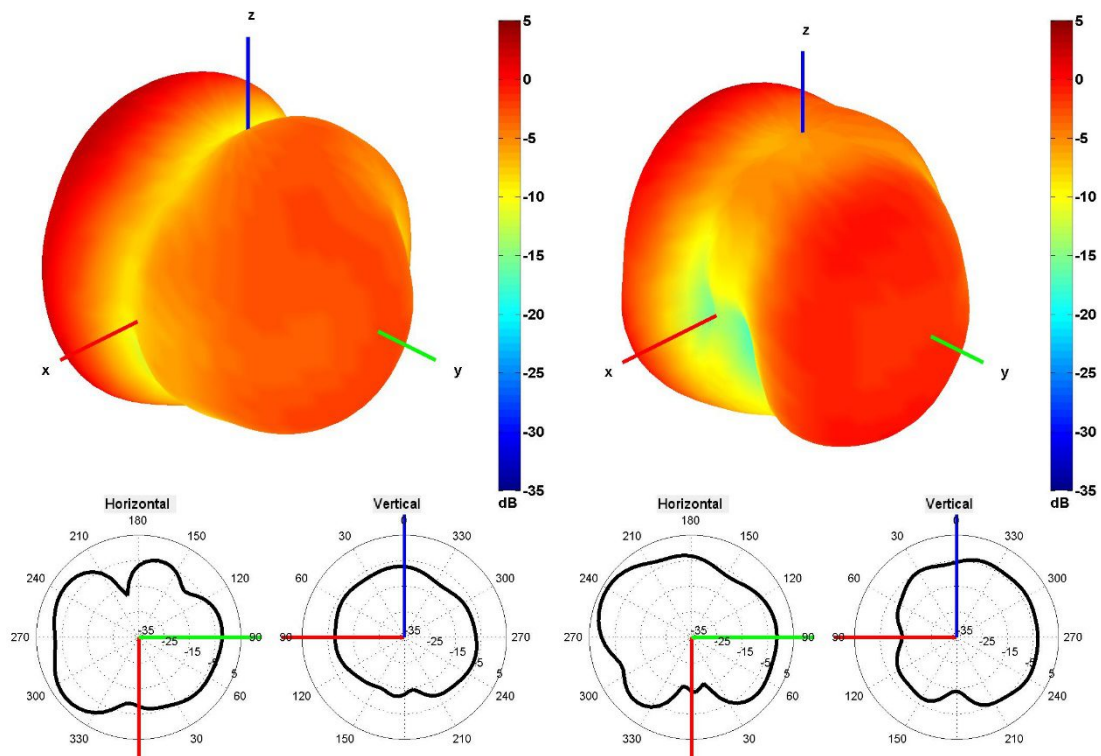

2350 and 2600 MHz Radiation pattern

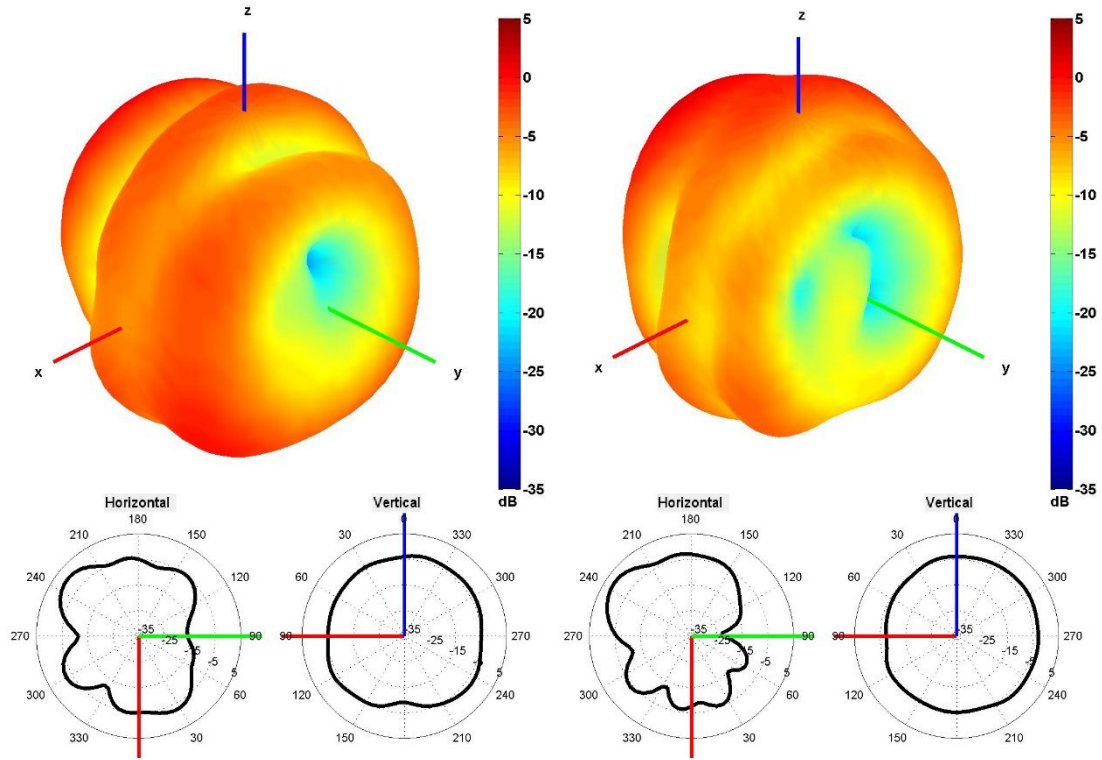

3350 and 3600 MHz Radiation pattern

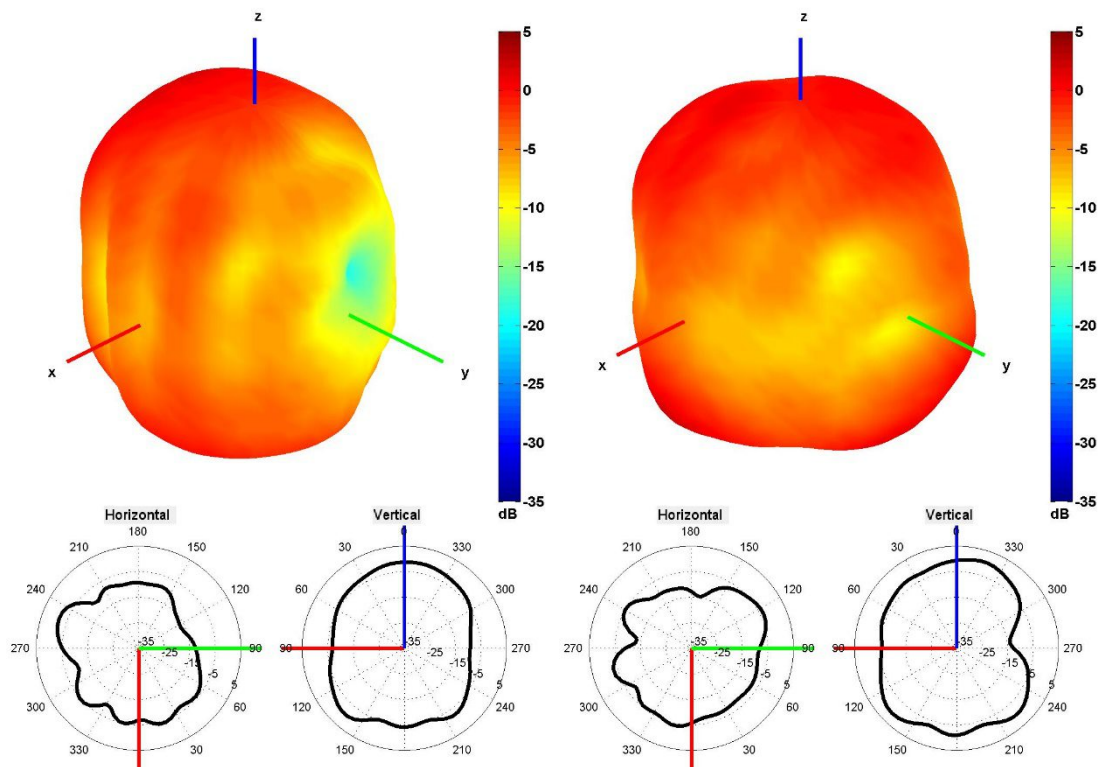

4500 and 5500 MHz Radiation pattern

## 4. PCB Layout

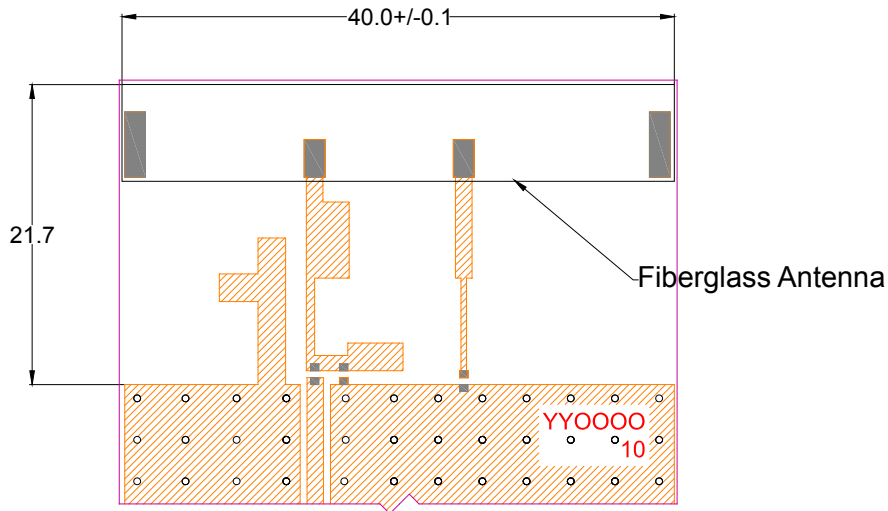

Minimum area required for antenna integration (40mm × 21.7mm)

- Solder Region
- Copper Region
- Copper-Free Region

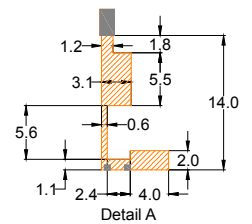
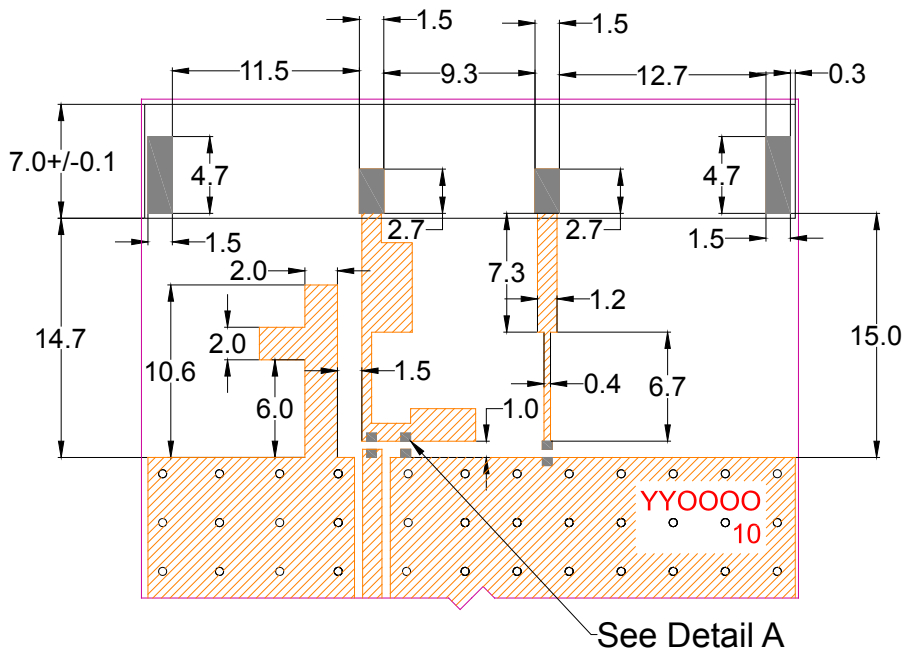

Tolerance of Linear Dimensions (unless otherwise indicated):

Dimension (mm)	Tolerance
0.5-6	+/- 0.05
6-30	+/- 0.07
30-50	+/- 0.1

Layout dimensions for antenna integration (mm)

- Solder Region
- Copper Region
- Copper-Free Region

## 5. Matching Network

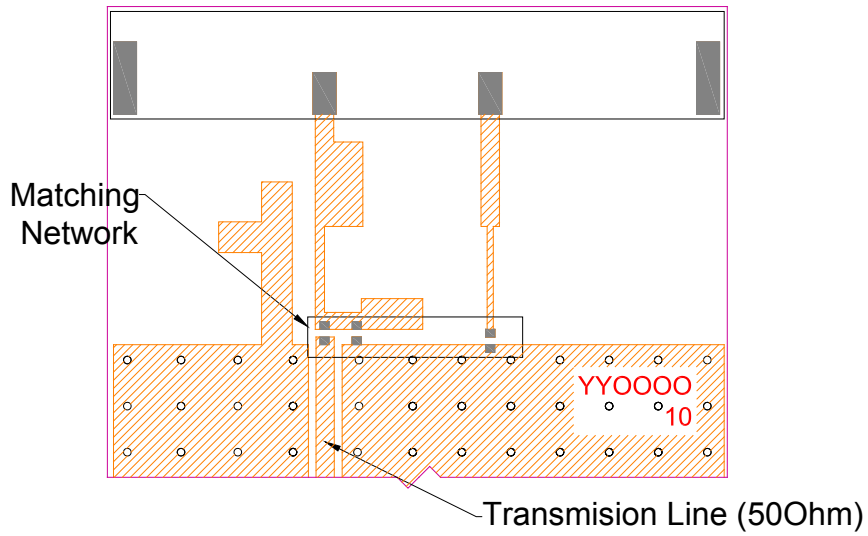

-  Solder Region
-  Copper Region
-  Copper-Free Region

Matching network drawing

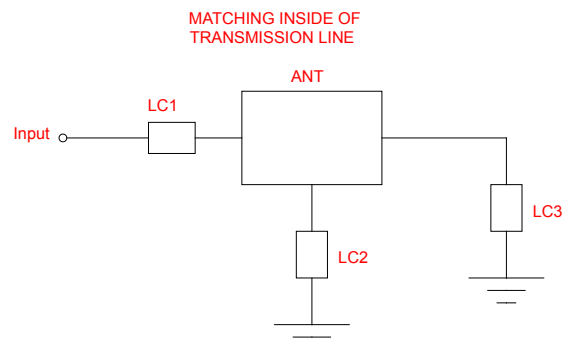
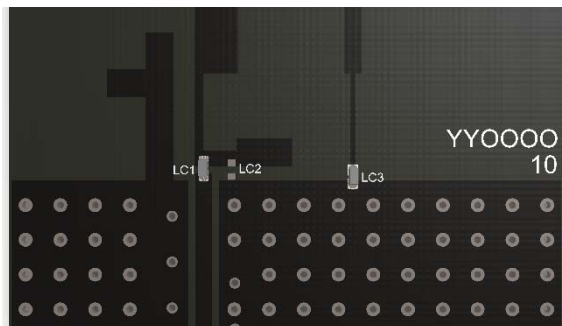

3D View of matching components and recommended values  
(LC1=00hm, LC2=OPEN, LC3=8.2nH)

## 6. Evaluation Board

140mm x 40.4mm

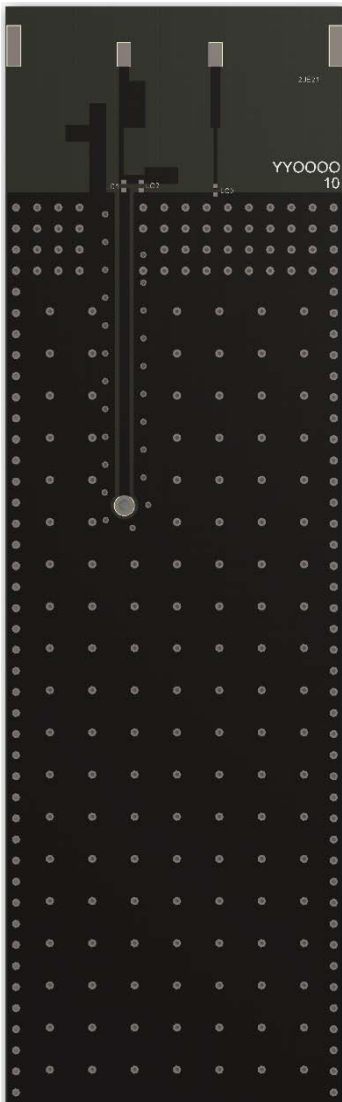

Front View without Antenna

140mm x 40.4mm

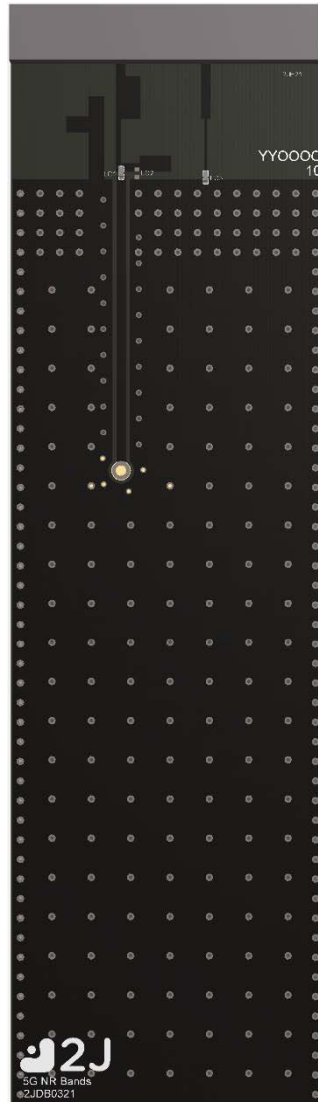

Front View with Antenna

140mm x 40.4mm

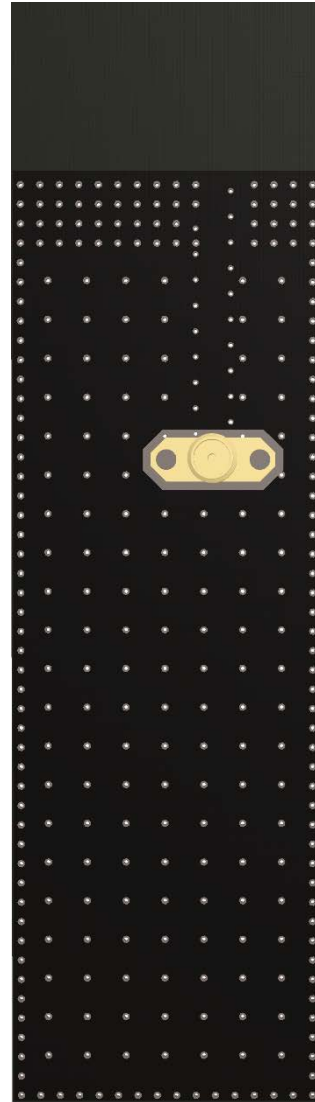

Back View

140mm x 40.4mm  
(PCB: 0.8mm, Antenna: 3mm,  
Connector: 9.5mm)



Side View

## 7. Packaging

### PACKAGING SPECIFICATION

<b>Antenna</b>	2JE21
<b>REEL</b>	
<b>Max Quantity per Reel</b>	1500
<b>REEL CARTON</b>	
<b>Reels per Carton</b>	2
<b>Max Quantity per Carton</b>	3000
<b>Reel Carton Dimensions (cm)</b>	36.5 x 36.5 x 16
<b>Reel Carton Weight (Kg)</b>	7
<b>PALLET</b>	
<b>Max Cartons per Pallet</b>	42
<b>Cartons per Layer</b>	6
<b>Number of Layers</b>	7
<b>Max Quantities per Pallet</b>	126,000
<b>Total Cartons Dimensions (cm)</b>	109.5 x 73 x 112
<b>Total Cartons Weight (Kg)</b>	294
<b>Pallet size and weight not included above</b>	
<b>Typical Pallet Size (cm)</b>	120 x 100 x 14.4
<b>Typical Pallet Weight (Kg)</b>	5-25

## 8. Tape and Reel Information

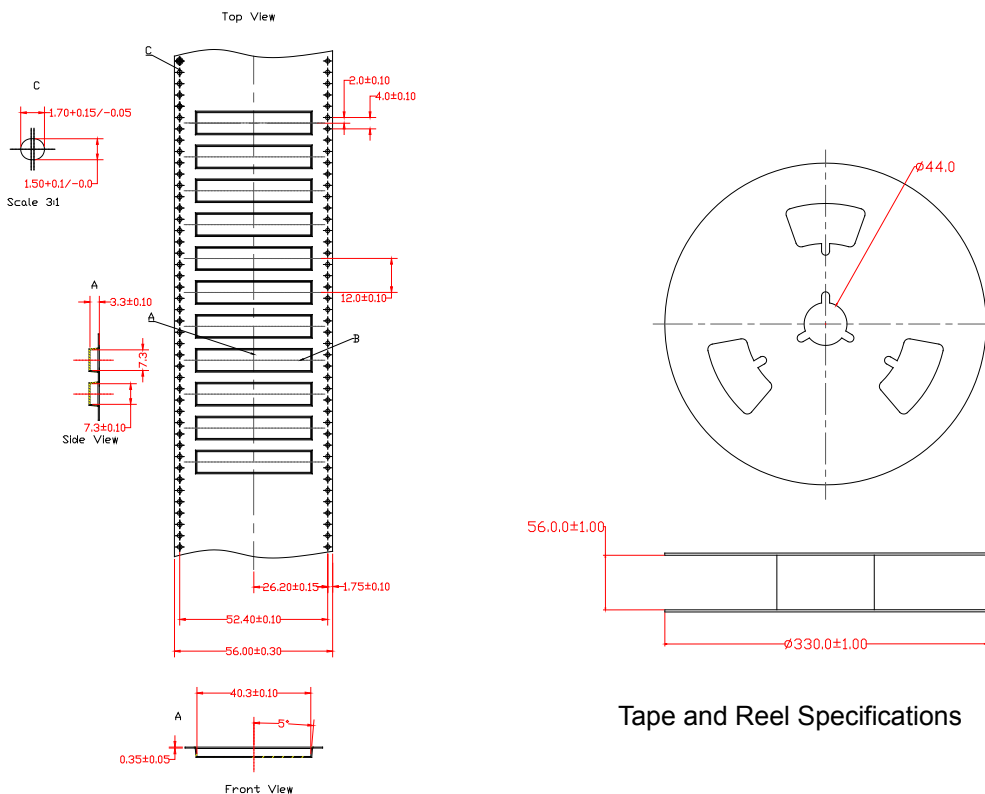

Tape and Reel Specifications

## REFLOW TEMPERATURE PROFILE

Minimum Recommended Reflow Profile

	Method of heat transfer	Controlled hot air convection
1	Average temperature gradient in preheating	2.5 °C/s
2	Soak time	2-3 minutes
3	Max temperature gradient in reflow	3 °C/s
4	Time above 217 °C	Max 30 sec
5	Peak temperature in reflow	230 °C for 10 seconds
6	Temperature gradient in cooling	Max -5 °C/s

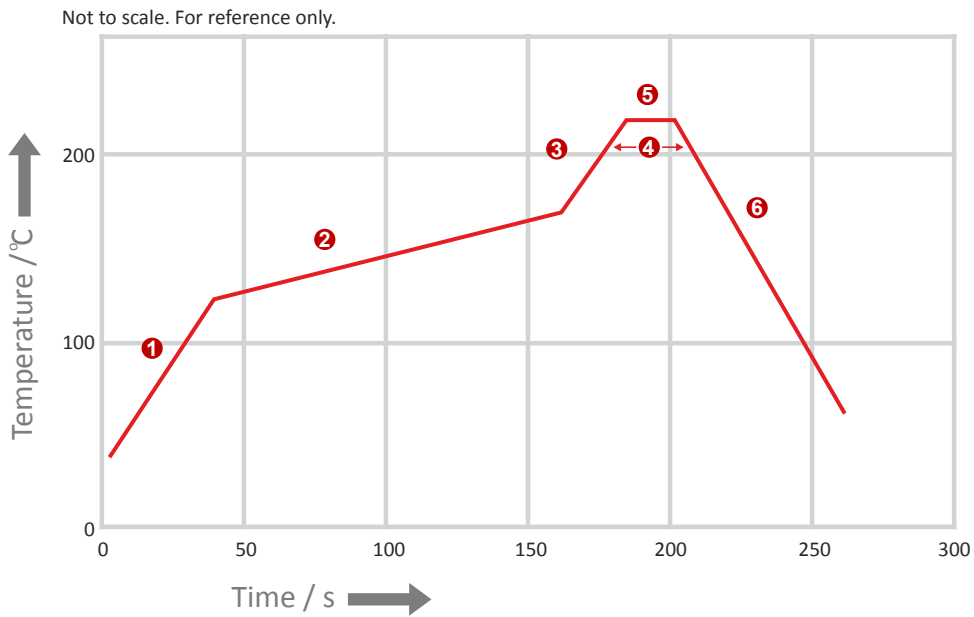

### REFLOW TEMPERATURE PROFILE

Maximum Recommended Reflow Profile

	Method of heat transfer	Controlled hot air convection
1	Average temperature gradient in preheating	2.5 °C/s
2	Soak time	2-3 minutes
3	Max temperature gradient in reflow	3 °C/s
4	Time above 217 °C	Max 60 sec
5	Time above 230 °C	Max 50 sec
6	Time above 250 °C	Max 10 sec
7	Peak temperature in reflow	260 °C for 5 seconds
8	Temperature gradient in cooling	Max -5 °C/s

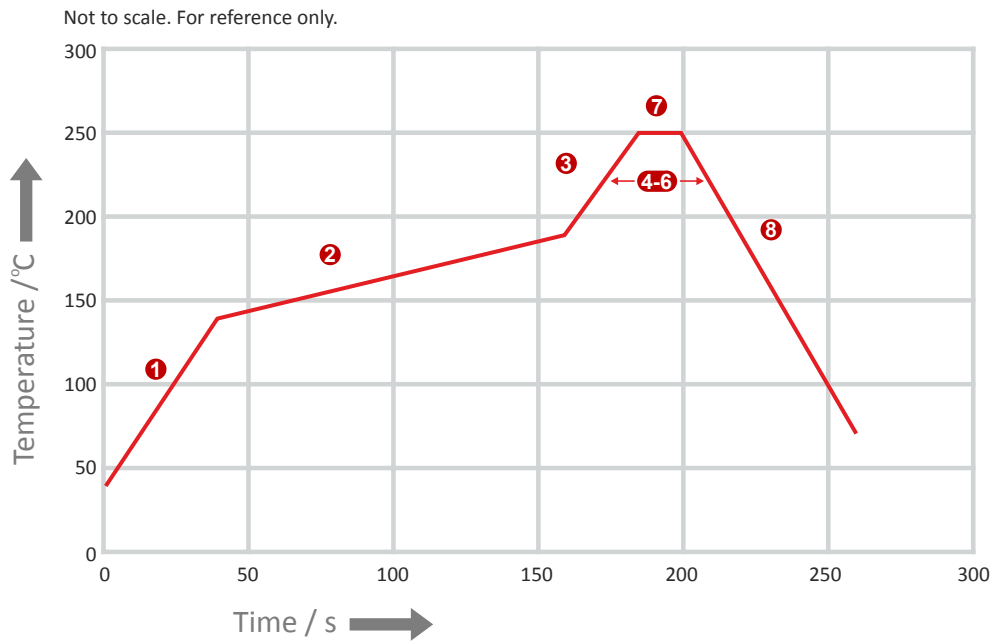



## 9. Antenna drawings

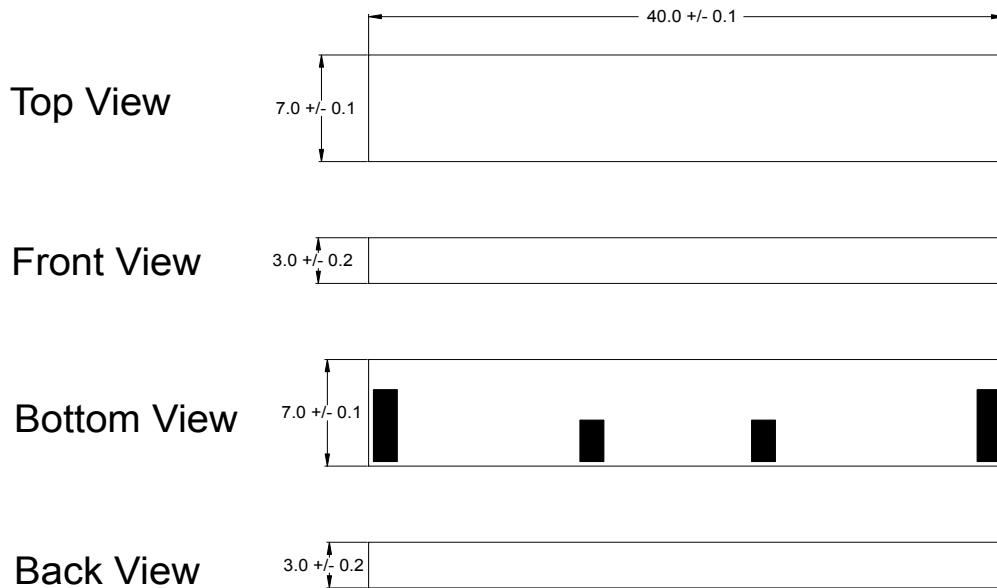

Dimensions for fiberglass antenna 40 x 7 x 3 mm +/-0.2mm

## 10. Antenna Images

